

TABLE OF CONTENTS

Traditional Aluminum Holders	2-7
Euro Sign System	8-11
Premier Frames	12-13
Premier Plus Frames	14-17
Architectural Aluminum Frames	18-23
Custom Shaped Frames	23
Heavy Architectural Frames	24
Frame Supplies	25
Decorative Bars	26-27
Curves	28-31
Frames with Lenses	32-33
Xterior Frames	34-35
EZ Signs	36-37
Architectural Frames In Molded Plastic	38-41
Designer Plastic Frames	42-43
Designer 2 Plastic Frames	44-45
Custom Acrylic Fabrication	46
Accessories and Supplies	47-48
Sales Brochures & Kits	49

TRADITIONAL *Nameplates and Sign Holders*

Traditional holders for desks, counters, walls and doors enhance the signs that serve you daily.

SECOND FLOOR

- ↑ ALLERGIES
- CASHIER
- LOBBY
- ← EXIT
- ↑ X-RAY
- ↑ PHYSICAL THERAPY

TOM VISOSKY

EMPLOYEES ONLY

Stock Room

 **NO SMOKING PLEASE**

PARKER MUNCIE
Account Executive

Robert Cullen

Judy North
Principal

All Fees
Must Be Paid Upon
Receipt of Service

INFORMATION

RECEPTION

TELEPHONE

KARIN WEST

DESK HOLDERS

Sign holders for the desk are designed in many styles and sizes. Holders are highly polished and anodized in Polished Rose Gold or Polished Silver, enhancing any decor. Styles and sizes are indicated by part number and length. Custom lengths and three custom colors, Matte Black, Satin Silver, and Polished Yellow Gold are available by special order at no extra cost and 7 to 10 days production time. Arch Bronze, JRS Bronze, Satin Yellow Gold, and Satin Rose Gold are also available upon request for a 25% up charge and up to 4 week delivery.

Part No.	Insert Size		Available Lengths			
	A	B				
85	3/4"	1/16"	4"	6"	8"	10"
25	1"	1/16"	6"	7"	8"	10"
54	1 1/4"	1/16"	6"	7.5"	8"	10"
70	1 1/2"	1/16"	7.5"	8"	10"	
19	1 1/2"	1/8"	7.5"	8"	10"	
14	1 5/8"	1/16"	7.5"	8"	10"	
48	2"	1/16"	8"	10"	12"	
11	2"	1/8"	8"	10"	12"	
16	3 1/4"	1/8"	10"	12"		
483	2"	3/32"	8"	10"	12"	

Part No.	Insert Size		Available Lengths	
	A	B		
59	2"	1/16"	8"	10"

Part No.	Insert Size		Available Lengths		
	A	B			
31	1 1/2"	1/16"	8"	9"	10"
30	2"	1/16"	8"	10"	

Part No.	Insert Size		Available Lengths
	A	B	
34	2"	1/16"	8"

Custom lengths are available.

All holders and frames can be combined for quantity discounts.

See price list for current pricing and quantity discounts.

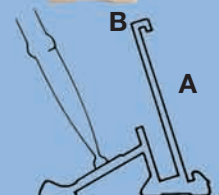
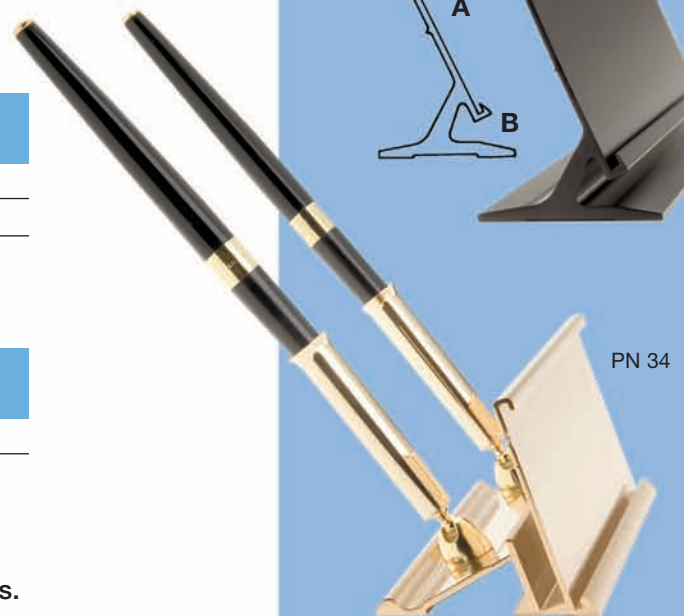
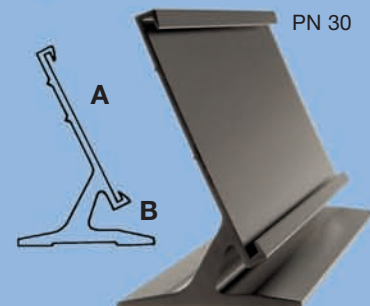
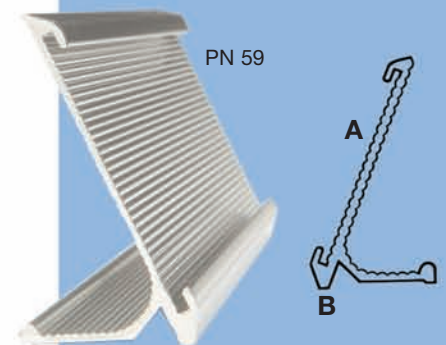
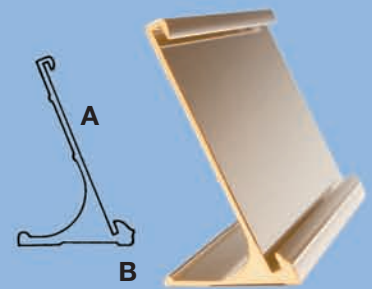

HELPFUL ORDERING INSTRUCTIONS: Make certain to include the following information: Part No., Length, Color and highlight any special instructions.

COUNTER & DESK BASES

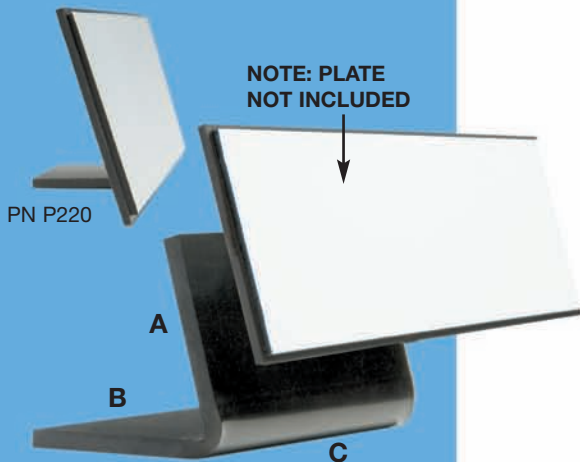
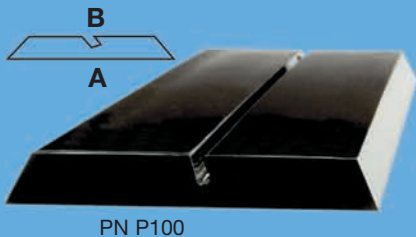
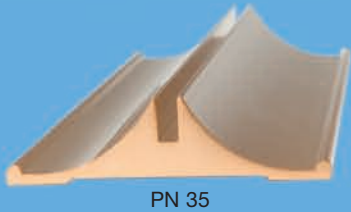
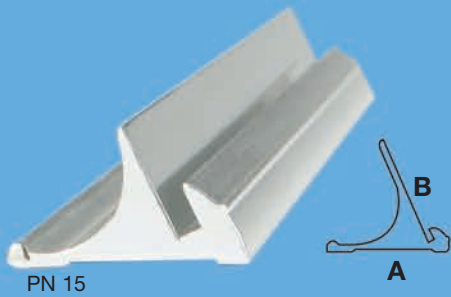

Sign bases for the desk and counter are designed to support both small and large signs. Holders are highly polished and anodized in Polished Rose Gold or Polished Silver, enhancing any décor. Styles and sizes are indicated by part number and length. Custom lengths and three custom colors, Matte Black, Satin Silver and Polished Yellow Gold are available by special order at no extra cost. Arch Bronze, JRS Bronze, Satin Yellow Gold and Satin Rose Gold are also available upon request for a 25% up charge and up to 4 weeks delivery.

Part No.	Size		Max. Sign Height	Available Lengths			
	A	B					
15	3/4"	1/16"	2"	6"	7 1/2"	8"	10"
50	15/16"	1/16"	3"	6"	8"	10"	
97	1 7/16"	1/16"	7"	8"	10"	12"	
17	1 3/32"	1/8"	4"	8"	10"	12"	
55	2 1/2"	1/8"	8"	8"	10"	12"	

Part No.	Size		Max. Sign Height	Available Lengths			
	A	B					
40	1 1/4"	1/16"	3"	3 3/4"	5"	8"	10"

Part No.	Size		Max. Sign Height	Available Lengths			
	A	B					
35	1 1/4"	1/16"	6"	6"	8"	10"	
42	1 1/4"	1/8"	6"	6"	8"	10"	
22	2 1/2"	1/8"	12"	6"	8"	10"	12"
39	1 1/4"	3/32"	6"	6"	8"	10"	

Part No.	Size		Max. Sign Height	Available Lengths	
	A	B			
P100	2"	1/16"	6"	8"	10"

Available in clear or black only.

Part No.	Size		
	A	B	C
P220	1 1/8"	1 1/8"	2 5/16"

Available in black only.

Custom lengths are available with the exception of P100.

All holders and frames can be combined for quantity discounts.

See price list for current pricing and quantity discounts.

WALL & CORRIDOR BRACKETS

Sign holders for the door or wall are available in many stock sizes and lengths. Holders are highly polished and anodized in Polished Rose Gold or Polished Silver, enhancing any décor. Styles and sizes are indicated by part number and length.

Mounting holes are standard in all insert sizes from 1 1/4" to 4". Custom lengths and three custom colors, Matte Black, Satin Silver and Polished Yellow Gold are available by special order at no extra cost. Arch Bronze, JRS Bronze, Satin Yellow Gold and Satin Rose Gold are also available upon request for a 25% up charge up to 4 weeks delivery. Holders are available in Raw Aluminum finish. When ordered Raw, holes are NOT standard and must be requested. Holes available on parts 24" - 36" in length for an added charge.

A 36" length is provided without holes in the styles and sizes below for you custom sign requirements. There is a minimum of five 36" lengths per order in any size combination.

Part No.	Size		Available Lengths						
	A	B	4"	6"	8"	10"	12"	36"	
86	1/2"	1/16"	4"	6"	8"	10"	12"	36"	
100	5/8"	1/16"	4"	6"	8"	10"	12"	36"	
44	3/4"	1/16"	4"	6"	8"	10"	12"	36"	
28	1"	1/16"	4"	6"	8"	10"	12"	36"	
47	1 1/4"	1/16"	4"	6"	8"	10"	12"	36"	
29	1 1/2"	1/16"	4"	6"	8"	10"	12"	36"	
95	1 1/2"	1/8"	4"	6"	8"	10"	12"	36"	
46	1 5/8"	1/16"	4"	6"	8"	10"	12"	36"	
87	1 3/4"	1/16"	4"	6"	8"	10"	12"	36"	
88	1 3/4"	1/8"	4"	6"	8"	10"	12"	36"	
36	2"	1/16"	4"	6"	8"	10"	12"	36"	
94	2"	1/8"	4"	6"	8"	10"	12"	36"	
89	2 1/2"	1/16"	4"	6"	8"	10"	12"	36"	
90	2 1/2"	1/8"	4"	6"	8"	10"	12"	36"	
37	3"	1/16"	4"	6"	8"	10"	12"	36"	
52	3"	1/8"	4"	6"	8"	10"	12"	36"	
49	4"	1/16"	4"	6"	8"	10"	12"	36"	
51	4"	1/8"	4"	6"	8"	10"	12"	36"	
363	2"	3/32"	4"	6"	8"	10"	12"	36"	

Part No.	Size		Available Lengths			
	A	B	4"	6"	8"	36"
56	1"	1/16"	4"	6"	8"	36"
57	1 1/2"	1/16"	6"	8"	10"	36"
58	2"	1/16"	8"	10"	12"	36"

Part No.	Size		Available Lengths						
	A	B	2"	3"	4"	5"	10"	12"	36"
38	2 1/2"	1/8"	2"	3"	4"	5"	10"	12"	36"

Screws available in BG, BS, BL.

See page 47 for information on Fangs, a fabric partition mounting solution.

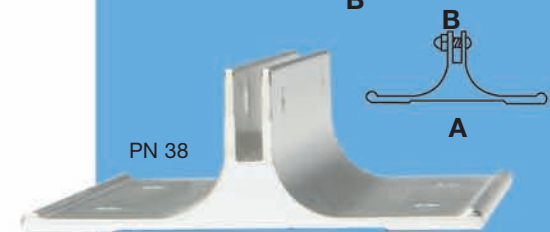
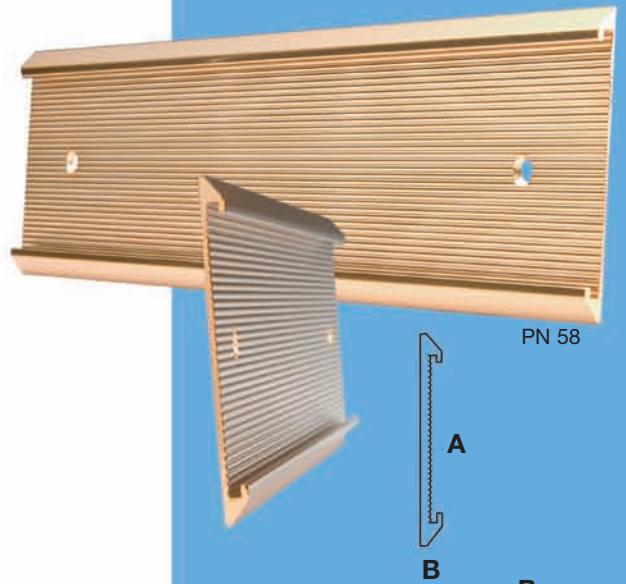
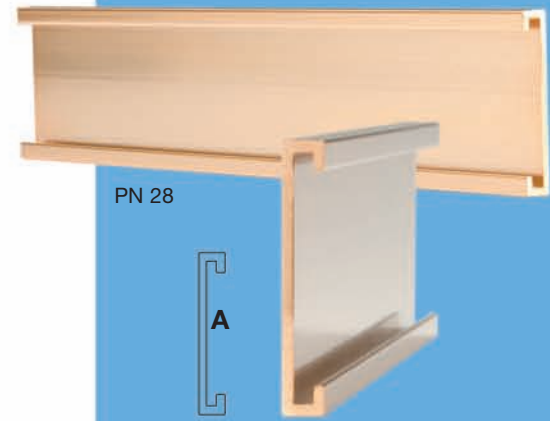

HELPFUL ORDERING INSTRUCTIONS: Make certain to include the following information: Part No., Length, Color and highlight any special instructions, such as NO HOLES.

MULTIPLE SIGN HOLDERS

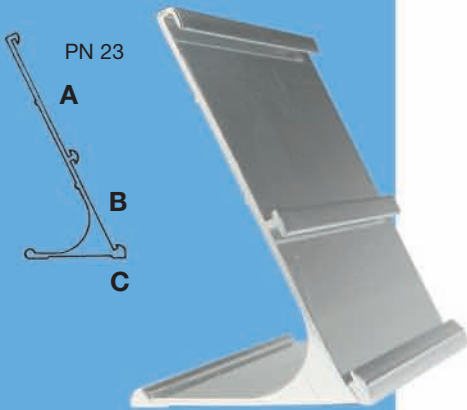

Sign holders for double signs or multiple uses are designed in various styles and sizes. Holders are highly polished and anodized in Polished Rose Gold or Polished Silver, enhancing any décor. Styles and sizes are indicated by part number and length. Custom lengths and three custom colors, Matte Black, Satin Silver and Polished Yellow Gold are available by special order at no extra cost. Arch Bronze, JRS Bronze, Satin Yellow Gold and Satin Rose Gold are also available upon request for a 25% up charge and up to 4 weeks delivery.

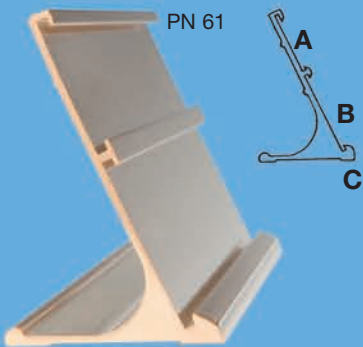

Part No.	A	Size B	C	Available Lengths		
23	2"	1 1/2"	1/16"	9"	10"	12"

Part No.	A	Size B	C	Available Lengths		
61	1"	1 1/4"	1/16"	8"	10"	

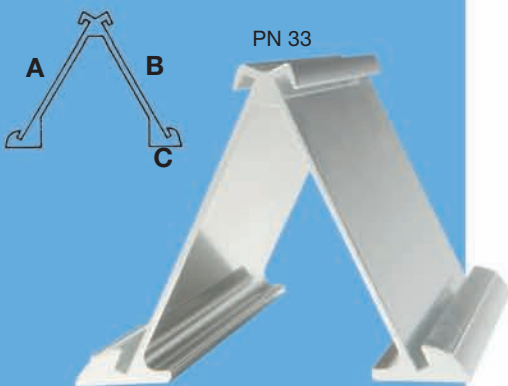

Part No.	A	Size B	C	Available Lengths		
71	1 1/4"	1 1/4"	1/16"	6"	8"	10"
33	2"	2"	1/16"	8"	10"	

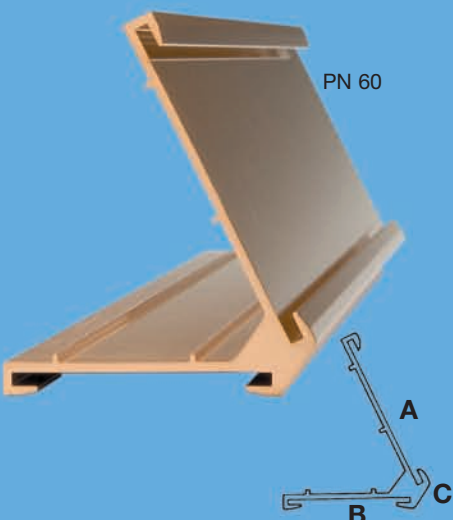

Part No.	A	Size B	C	Available Lengths		
60	2"	1 1/2"	1/16"	8"	10"	

Custom lengths are available.

All holders and frames can be combined for quantity discounts.

See price list for current pricing and quantity discounts.

MULTIPLE WALL BRACKET

Sign holders for multiple signs are designed to be used as individual signs or stacked on top of one another to form mini-directories. The special beveled edges insure a finished look with endless combinations. Holders are highly polished and anodized in Polished Rose Gold or Polished Silver, enhancing any décor. Styles and sizes are indicated by part number and length. Custom lengths and three custom colors, Matte Black, Satin Silver and Polished Yellow Gold are available by special order at no extra cost. Arch Bronze, JRS Bronze, Satin Yellow Gold and Satin Rose Gold are also available upon request for a 25% up charge and up to 4 weeks delivery. Holes are standard on all parts up to 24" in length. Holes available on parts 24" x 36" in length for an added charge.

Part No.	A	Size B	C	Available Lengths			
115	2"	1"	1/16"	6"	8"	10"	36"
107	1 1/2"	1"	1/16"	6"	8"	10"	36"
108	1 1/4"	3/4"	1/16"	6"	8"	10"	36"

Part No.	A	Size B	C	D	Available Lengths			
106	1"	1"	1"	1/16"	6"	8"	10"	36"
112	1 1/2"	1 1/2"	1 1/2"	1/16"	6"	8"	10"	36"
109	3/4"	3/4"	3/4"	1/16"	6"	8"	10"	36"

Part No.	A	Size B	C	Available Lengths			
104	1"	1"	1/16"	6"	8"	10"	36"
110	3/4"	3/4"	1/16"	6"	8"	10"	36"

Part No.	A	Size B	Available Lengths			
103	1"	1/16"	6"	8"	10"	36"
114	3/4"	1/16"	6"	8"	10"	36"

No holes on Part Nos. 103 & 114

Extruded moldings and dividers for your custom sign requirements are available in 36" lengths in Polished Rose Gold and Polished Silver. Matte Black, Satin Silver and Polished Yellow Gold are available by special order at no extra cost. Arch Bronze, JRS Bronze, Satin Yellow Gold and Satin Rose Gold are also available upon request for a 25% up charge and up to 4 weeks delivery. There is a minimum of five 36" lengths per order in any size combinations.

Part No.	Insert Size	Length	Description
75	1/16"	36"	J Molding
83	1/8"	36"	J Molding
76	1/16"	36"	Divider
84	1/8"	36"	Divider
27	1/8"	36"	See Image ▶
78	1/16"	36"	See Image ▶
77	1/16"	36"	See Image ▶

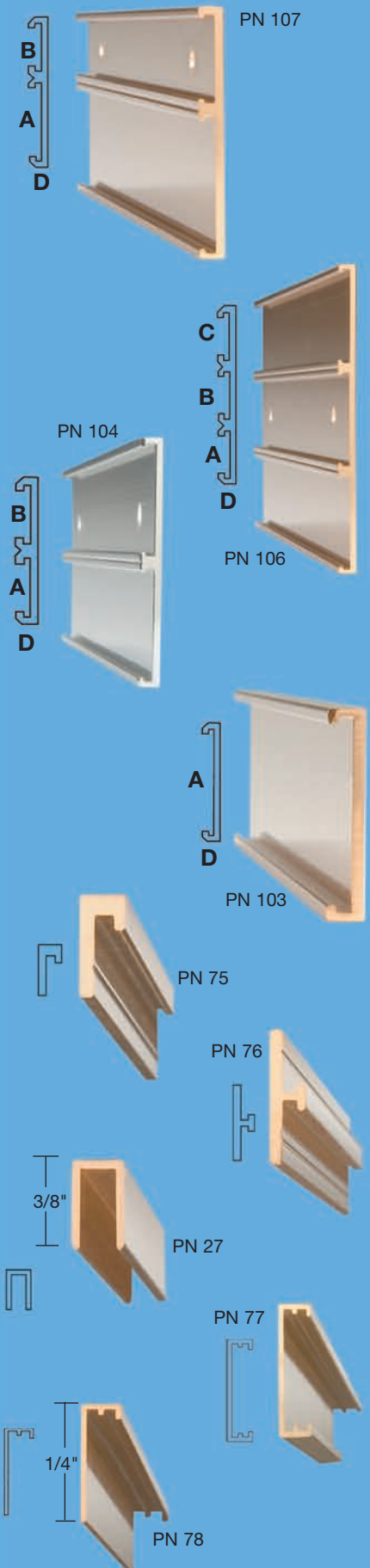

HELPFUL ORDERING INSTRUCTIONS: Make certain to include the following information: Part No., Length, Color and highlight any special instructions, such as NO HOLES.

EURO SIGN SYSTEM

The simple sign solution at the best cost.

The EURO Sign System with 20 standard sizes in 5 anodized colors is designed to make tamper resistant signs and directories. The clean lines of both 3/8" round or 3/8" square extrusions make an attractive, functional, inexpensive solution to interior signage. **AVAILABLE COLORS: SATIN SILVER, POLISHED SILVER, MATTE BLACK, POLISHED YELLOW GOLD, POLISHED ROSE GOLD.**

LEVEL 3	
←	→
Personnel	Conference Rooms A & B
Administration	Admitting / Discharge
Accounting / Payroll	Medical Records
Human Resources	Public Relations
	Education Dept.

9221 Corbin Avenue Building Five		
Johnson Insurance Group		Corporate Creative 200
Claims	101	RDN Fashions 205
Accounting	105	BACA Corp 210
Marketing	110	Blue Moon Limo 220
Sales	120	TJM Travel 230
		Lowell Enterprises 240

Education Department

DSI DIVERSIFIED SECURITY INC.	
Tom Worrel	A
Chuck Rhodes	B
Susan Morales	C
Tamra Culvin	D

**MYER &
FRANK**
ATTORNEYS
AT LAW

310



EURO SIGN SYSTEM

Square and round head screws are specially designed to cap off extrusions, and lock in the holder assemblies. Simply remove the top screws and slide sign assemblies out for a quick change. Screw holes are tapped for repeated use. Custom sizes are available. Please fax a quote request to our Quote Department. Available colors: Satin Silver, Polished Silver, Matte Black, Polished Yellow Gold and Polished Rose Gold. Call for quote on anodized finishes not listed. Prices are for frames up to 100 perimeter inches. Please request a quote for larger frames. Frames may be subject to crating charge. Maximum frame size is 39" x 39".

2" x 8", 2" x 10" and standard size directories in the Euro System use standard JRS holders (#36, 106, 109, 112, 89 and 37). Sign assemblies with sizes such as 6" x 6", 8" x 8", 12" x 12" etc. and other custom sizes use 2 #75 J-moldings as top and bottom rails for sign assemblies.

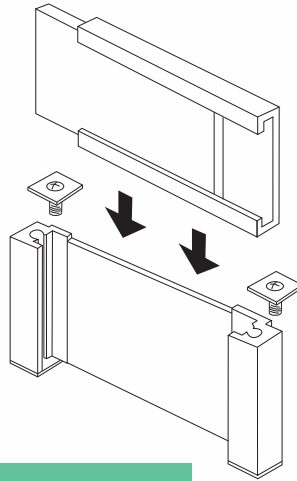

Note: All Euro Holders hold 1/16"

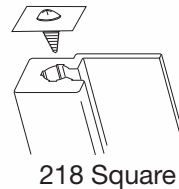

218 Square

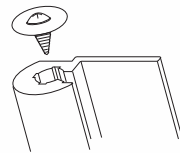

220 Round

Part No.	Size
218208 Square	2" x 8"
220208 Round	2" x 8"
218210 Square	2" x 10"
220210 Round	2" x 10"
218312 Square	3" x 12"
220312 Round	3" x 12"
218618 Square	6" x 18"
220618 Round	6" x 18"
218606 Square	6" x 6"
220606 Round	6" x 6"
2181212 Square	12" x 12"
2201212 Round	12" x 12"
218808 Square	8" x 8"
220808 Round	8" x 8"
218806 Square	8" x 6"
220806 Round	8" x 6"

All holders and frames can be combined for quantity discounts.

See price list for current pricing and quantity discounts.

NOTE: For special colors call for lead time.

Fax Office

EuroDesk

Add a matching aluminum base to any of the standard size frames shown on the page to create an elegant and professional looking desk sign frame. Bases are available in 2", 3" and 4" widths and are made from a premium aluminum alloy.

To order, simply add a "D" to the end of the Part Number – 218208D.

2" Base – Signs 3" or less in height

3" Base – Signs 3-8" in height

4" Base – Signs 8-12" in height

2" Minimum Sign Height

12" Maximum Sign Height

EURO SIGN SYSTEM

Holds 1/16" Inserts

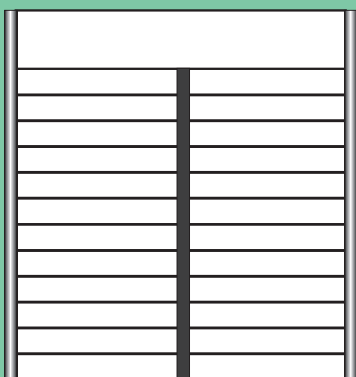
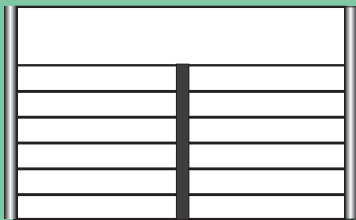

Twelve mini directories round out the Euro Sign System. Sign assemblies are stacked to create multiple lines.

Specially designed machine screws lock the entire group of sign assemblies in place. Simply remove the top screws and slide sign assemblies out for a quick change. Screw holes are tapped for repeated use. Vertical dividers are used for multiple columns.

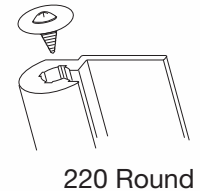
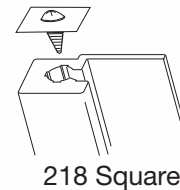
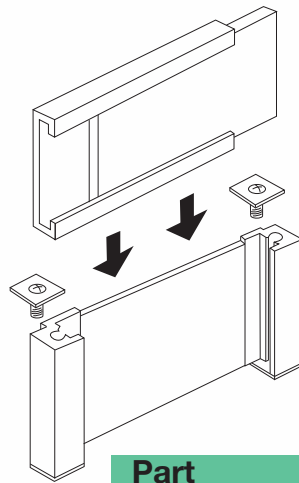

Part No.	Header Size	Slots/Size	Approximate Size
218D11 Square 220D11 Round	2"	3 Slots 3/4" x 8"	4 3/4" x 8"
218D21 Square 220D21 Round	2"	6 Slots 3/4" x 8"	7 1/4" x 8"
218D31 Square 220D31 Round	2"	12 Slots 3/4" x 6"	7 1/4" x 12"
218D41 Square 220D41 Round	2"	24 Slots 3/4" x 6"	12 1/2" x 12"
218D12 Square 220D12 Round	2"	3 Slots 1" x 8"	5 1/2" x 8"
218D22 Square 220D22 Round	2"	6 Slots 1" x 8"	8 7/8" x 8"
218D32 Square 220D32 Round	2 1/2"	12 Slots 1" x 6"	9 1/4" x 12"
218D13 Square 220D13 Round	2 1/2"	3 Slots 1 1/2" x 10"	7 1/2" x 10"
218D23 Square 220D23 Round	2 1/2"	6 Slots 1 1/2" x 10"	12 1/4" x 10"
218D42 Square 220D42 Round	2 1/2"	24 Slots 1" x 6"	16" x 12"
218D33 Square 220D33 Round	3"	12 Slots 1 1/2" x 8"	12 7/8" x 16"
218D43 Square 220D43 Round	3"	24 Slots 1 1/2" x 8"	22 1/2" x 16"

Prices are for frames up to 100 perimeter inches. Please request a quote for larger frames. Frames may be subject to crating charges. Maximum frame size is 39" x 39".

All holders and frames can be combined for quantity discounts.

See price list for current pricing and quantity discounts.

EURO SIGN SYSTEM

ENDLESS
POSSIBILITIES FOR
SIGNAGE
SOLUTIONS!



**CUSTOM
SIZES ARE
AVAILABLE.**

**FAX FOR A
QUOTE.**

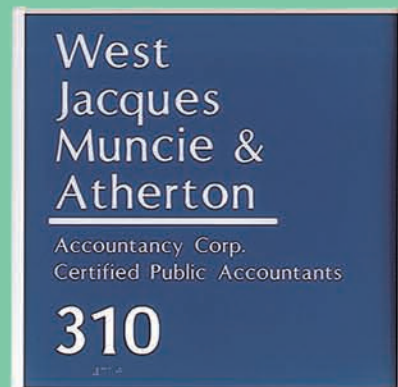

PREMIER FRAMES

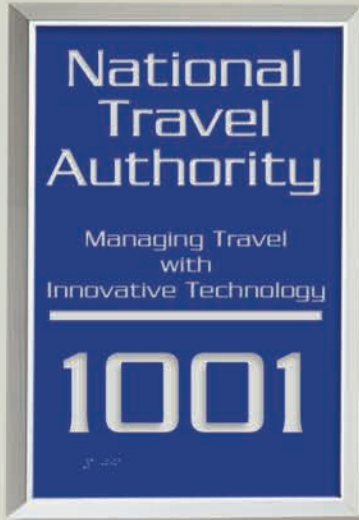

Premier frames are precision mitered from a premium aluminum alloy in different styles – 1/2" beveled, radius, and boxed. Each style is available in **POLISHED SILVER, POLISHED YELLOW GOLD, POLISHED ROSE GOLD, SATIN SILVER, MATTE BLACK, SATIN YELLOW GOLD, SATIN ROSE GOLD AND ARCH BRONZE.**



1/2" beveled, radiuses are precision mitered from premium aluminum alloy.

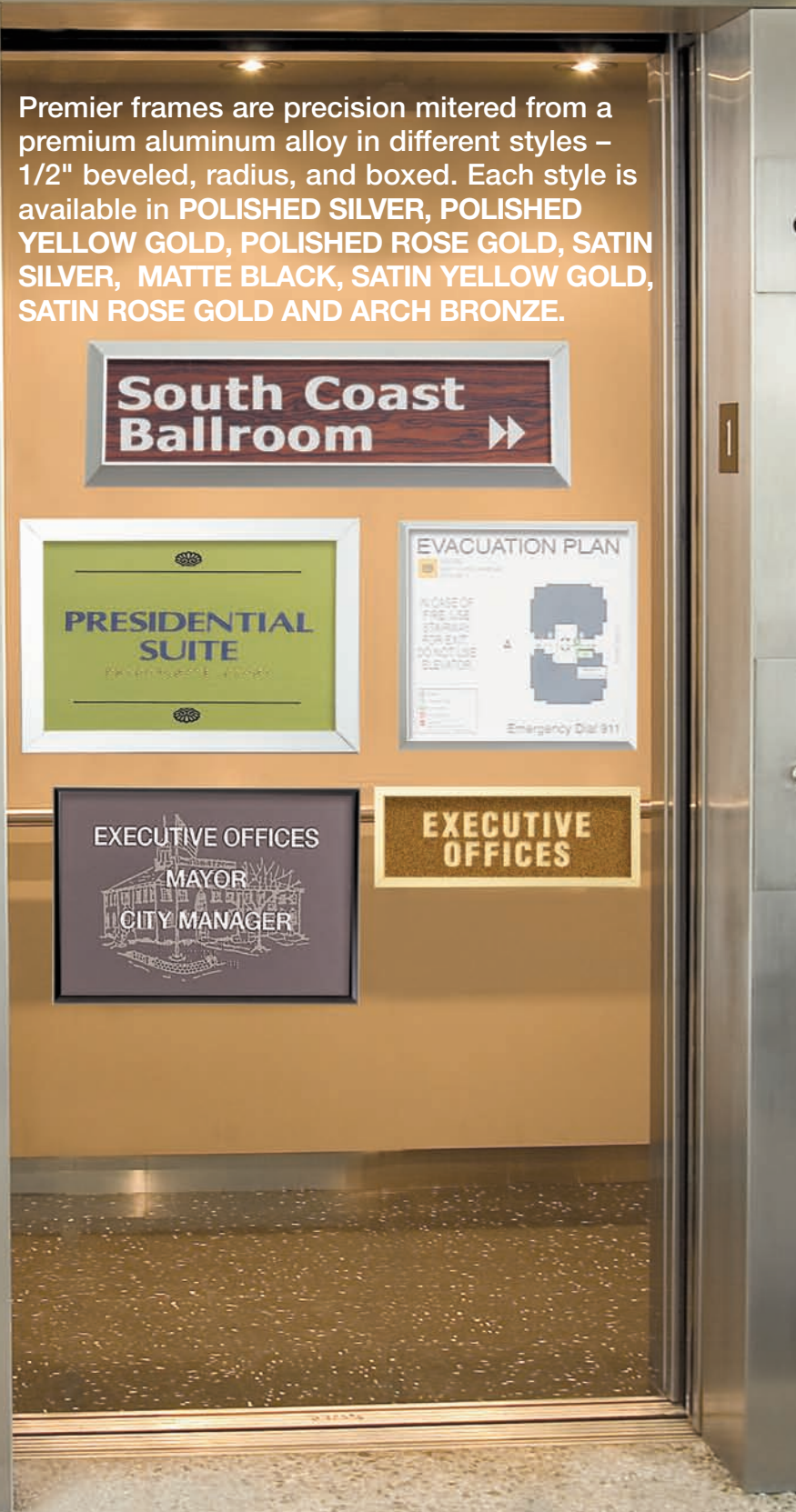

PREMIER FRAMES

Precision mitered from an extrusion of premium alloy in three professional styles – Beveled, Radiused, and Boxed – makes this sign system a top of the line favorite. Each style has several features that make professional signs simple:

- Each frame is designed for complete support of 1/16" sign material.
- Eight rich anodized colors are available in all three styles: Polished Silver, Satin Silver, Polished Yellow Gold, Satin Yellow Gold, Polished Rose Gold, Satin Rose Gold, Matte Black, and Arch Bronze.
- Minimum size 2" x 4". Maximum size 36" x 36".
- A trough 1/2" wide runs the entire inside perimeter of each frame which accommodates adhesive-backed 3M DUAL LOCK or Sign Snap so that a tamper-resistant plate snaps in and out with the use of a suction cup.
- Frames are designed for mounting to wall or door with double-sided tape or silicone-type adhesive. Holes will be provided upon request.

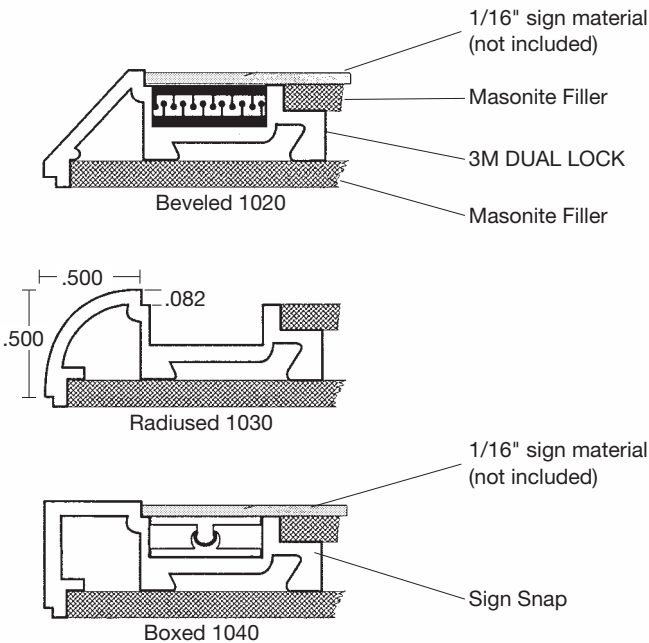

Trough for 1/2" 3M DUAL LOCK or Sign Snap

Precision Miter

Masonite Filler

ACCESSORIES

See page 47-48 for more accessories



BO9000 – 1 1/2" diameter Suction Cup

BO9450 – 1/2" x 12" Light 3M DUAL LOCK



BO9400 – 1/2" x 12" Dense 3M DUAL LOCK



3M DUAL LOCK B09400 AND B09450 can be combined for quantity break.

Sign Snap contains both top and bottom with adhesive.



BO9500 – 1/2" x 12" Sign Snap

Prices are for frames up to 100 perimeter inches. Fax for special quote on frames of 100 perimeter inches or greater. Frames may be subject to crating charges.

All holders and frames can be combined for quantity discounts.

Desk frame model available. Fax for a quote

See price list for current pricing and quantity discounts.

PREMIER PLUS

Premier Plus frames are precision mitered from a premium aluminum alloy in four different styles – 1/2" beveled, radius, boxed, and 1/4" boxed. Each style is available in POLISHED SILVER, POLISHED YELLOW GOLD, POLISHED ROSE GOLD, SATIN SILVER, MATTE BLACK, SATIN YELLOW GOLD, SATIN ROSE GOLD AND ARCH BRONZE.

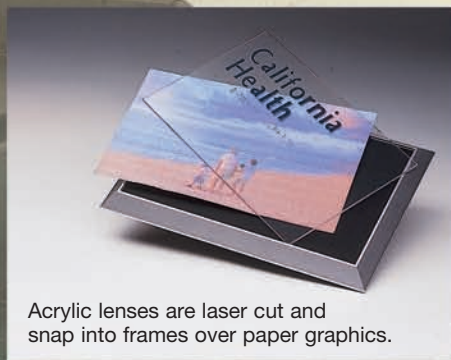
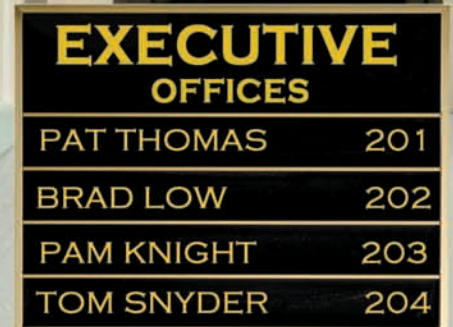

Acrylic lenses are laser cut and snap into frames over paper graphics.

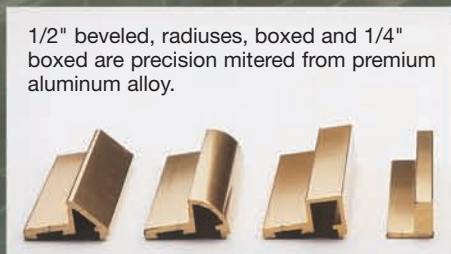

1/2" beveled, radiuses, boxed and 1/4" boxed are precision mitered from premium aluminum alloy.



PREMIER PLUS

Precision mitered from an extrusion of premium alloy in four professional styles: Beveled, Quarter Round, Boxed, and Quarter Inch Solid, this sign system is a top of the line favorite.

- Eight rich anodized colors are available in all four styles: Polished Silver, Satin Silver, Polished Yellow Gold, Satin Yellow Gold, Polished Rose Gold, Satin Rose Gold, Arch Bronze, and Matte Black.
- Seven powder coat finishes are available: Medium Gray, Pewter (light gray), Black, White, Almond, Brown, and Arch Brown.
- Each frame style is available with either a 3/16" or 5/16" inside depth. Inside depth must be specified when ordering.
- Frames are designed for mounting with double-sided tape or silicone adhesives. Holes will be provided only upon request.
- All frames are available with optional matte black metal inside, suitable for changeable magnetic signs for an additional cost. See price guide.
- Lenses are laser cut from semi-flexible .060 or .080 non glare acrylic and are designed with tabs that snap securely into frames.
- Lenses can easily be removed by using a suction cup placed in the center of the frame. *For lens pricing, please refer to pricing book. Maximum lens size is 200sq inches.
- Minimum size 2" x 4", Maximum size 36" x 36"

Please specify part number, inside dimension, inside depth, and color. Prices are for frames up to 100 perimeter inches. Fax for special quote on frames of 100 perimeter inches or greater. Frames may be subject to crating charges.

All holders and frames can be combined for quantity discounts.

See price list for current pricing and quantity discounts.

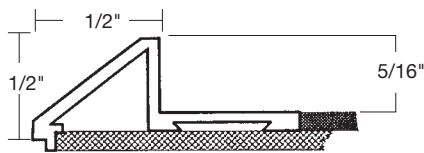

2020 Beveled

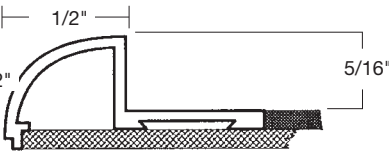
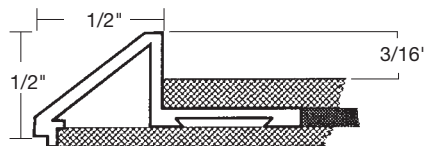

2030 Quarter Round

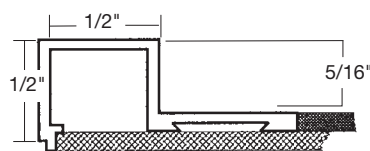
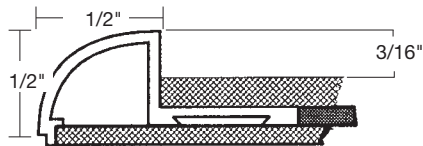

2040 Boxed

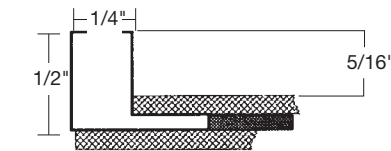
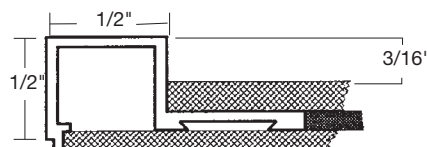

2050 Quarter Inch Solid



Masonite

HELPFUL ORDERING INSTRUCTIONS: When ordering, specify inside dimensions of frame, inside depth, and color. Divider frames are priced by adding the linear-inch of dividers, multiplying by per inch price, and adding the total to the perimeter price of each frame.

PREMIER PLUS *Divided Frames*

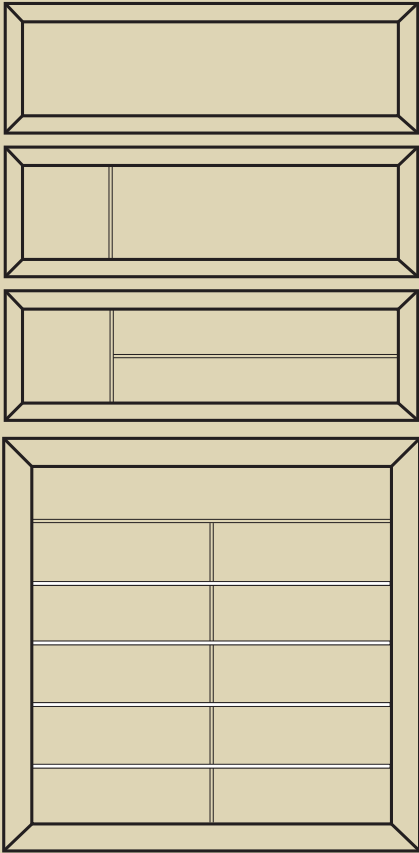

Premier Plus Frames are available with custom 1/8" or 1/4" dividers, in vertical or horizontal positions. Divided frames should be ordered by giving the inside dimension of each section and the overall inside dimension of the frame.

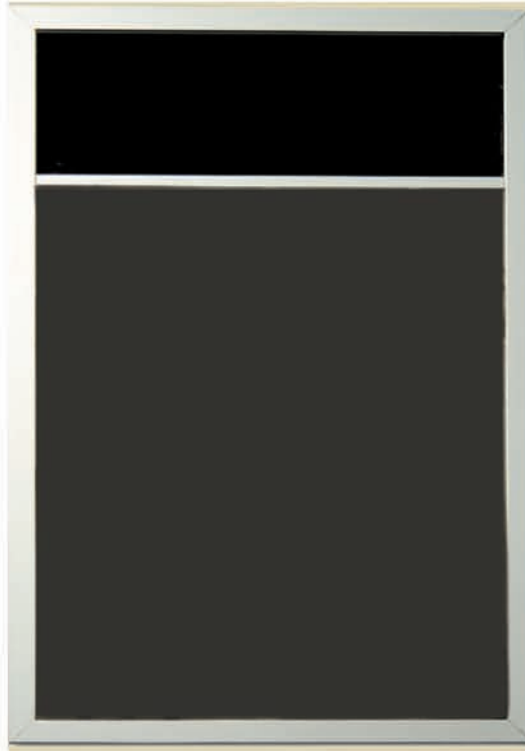

Divided frames may be ordered with the combination of a lens over one section with simple spaces for standard signage.



Divided frames are priced by adding the linear-inch of dividers, multiplying by per inch price, and adding the total to the perimeter price of each frame.

PREMIER PLUS *Custom Woodgrain Finish*

Wood appearance with added durability

Premier plus frames are available in a custom Walnut woodgrain finish. Coated in a durable, scratch resistant finish these frames require minimal maintenance in comparison to real wood frames.

- Inside depths of 3/16" or 5/16".
- Minimum size 2" x 4".
- Maximum size 36" x 36".
- Holes provided upon request.
- Lenses are NOT available with these frames.
- Frames are available with optional black metal inside, suitable for magnetic signs at an additional cost.



ARCHITECTURAL ALUMINUM FRAMES

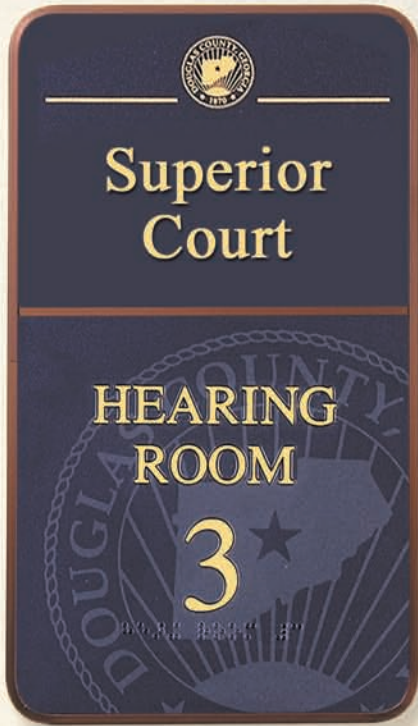

Specialty requirements for room identification and control are accomplished with these unique frames. They feature built-in changeable messages, magnetic changeable signs and frames with dividers. Frames are fabricated from continuous anodized aluminum extrusion in nine standard colors: **POLISHED SILVER, POLISHED YELLOW GOLD, POLISHED ROSE GOLD, SATIN SILVER, MATTE BLACK, JRS BRONZE, SATIN ROSE GOLD, SATIN YELLOW GOLD, AND ARCH BRONZE.**

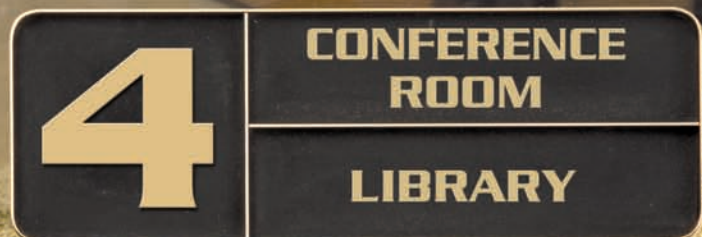

ARCHITECTURAL ALUMINUM FRAMES

Architectural Aluminum Frames are custom fabricated to your specifications based on the inside dimension of the frame. Custom Wall Frames, Frames with Dividers, Desk Frames, Counter Frames, Corridor and Ceiling Frames are all available with:

- Nine anodized finishes: Polished Rose Gold, Polished Yellow Gold, Polished Silver, Arch Bronze, JRS Bronze, Matte Black, Satin Rose Gold, Satin Yellow Gold, and Satin Silver
- Seven handsome powder coat finishes: Medium Gray, Pewter (light gray), Black, White, Almond, Brown, and Arch Brown.
- Available with a Matte Black inside metal surface for changeable magnetic signs for a additional charge. See price guide.
- **1/16" Wall Thickness** – Part number 240 square corner and 340 round corner frames are available with either a 3/8" or 1/2" outside depth plus a 1/8" backer plate. If no outside depth is specified, we will make the frames using the 3/8" outside depth. Frames without backer plates are available by request.

The inside depth (distance from surface of frame to inside masonite) is 3/16" for 3/8" frame and 5/16" for the 1/2" frame. 3/16" depth is available by request for the 1/2" frame. Please refer to the illustrations on this page for further details.

- **1/8" Wall Thickness** - Part number 540 square corner and 640 round corner frames are available with a 1/2" outside depth plus a 1/8" backer plate. Frames without backer plates are available by request.

The inside depth (distance from surface of frame to inside masonite) is 5/16". 3/16" depth is available by request. Please refer to the illustrations on this page for further details. Other custom depths are available by special quotation.

- Four radius corners – Inside dimensions 3/8", 1/2", 9/16", and 13/16". Unless otherwise specified we will make all radius frames with a 3/8" corner. Please specify if you want any other of our standard radius corners. Please call for pricing and availability on special radii.

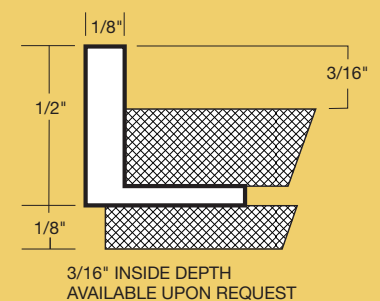
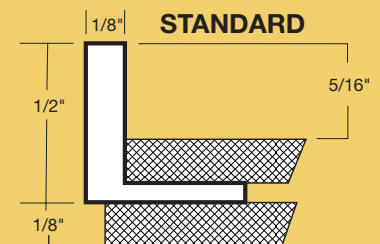
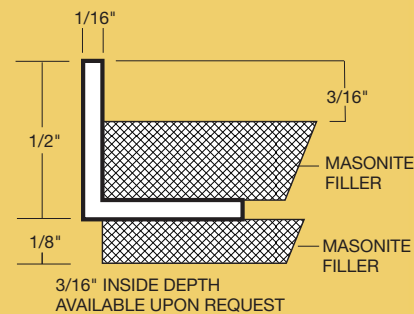
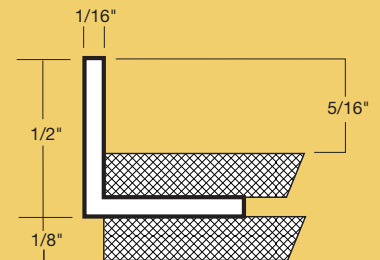
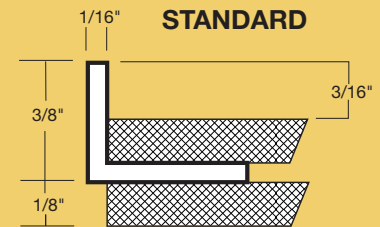
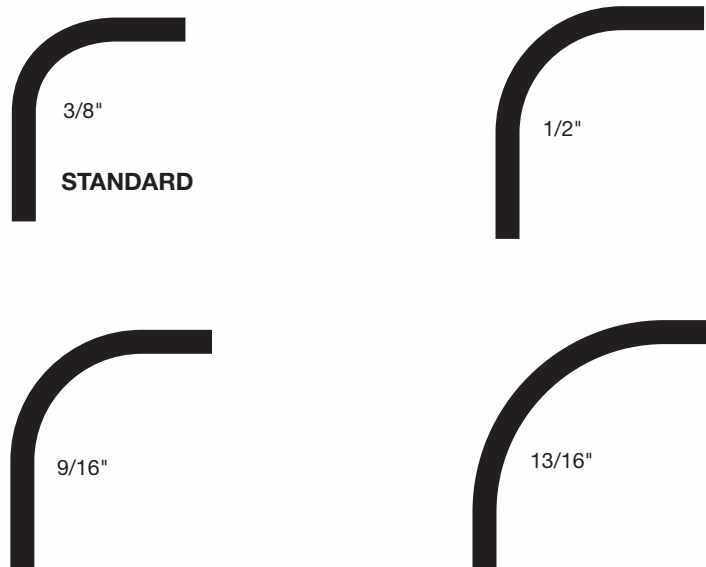

ARCHITECTURAL ALUMINUM FRAMES

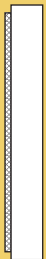

Door
or
Wall

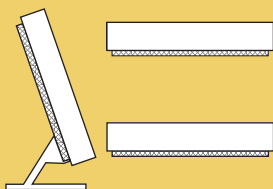

Desk

Architectural sign frames are custom fabricated from continuous aluminum extrusion from 1/16" or 1/8" wall thickness to your custom size requirements.

- Frames are available in nine anodized finishes: Polished Rose Gold, Polished Yellow Gold, Polished Silver, Arch Bronze, JRS Bronze, Matte Black, Satin Silver, Satin Rose Gold, and Satin Yellow Gold.
- Seven Powder Coat colors: Medium Gray, Pewter (light gray), Black, White, Almond, Brown, and Arch Brown. Powder Coat finish frames must have backs.
- Please specify part number, inside dimension, outside depth, inside depth, and color.
- All frames are available with optional matte black metal inside suitable for changeable magnetic signs. Black plastic is also available inside and outside instead of masonite. See price list (up charge applies).
- Prices are for frames up to 100 perimeter inches. Please fax for quote on larger frames.
- Holes available upon request.
- Net price is calculated by multiplying the perimeter inch price by the perimeter inches of the frame.

Example: A 340 2" x 8" = 2 + 8 + 2 + 8 = 20 perimeter inches.
20 perimeter inches x Cost per inch = Net Price

Add the length of all internal dividers to perimeter inches. •

DOOR OR WALL

Part No.	Wall Thickness	Corner ID	Frame Depth
340	1/16"	Round (3/8", 1/2", 9/16", 13/16")	3/8" or 1/2"
240	1/16"	Square	3/8" or 1/2"
640	1/8"	Round (3/8", 1/2", 9/16", 13/16")	1/2"
540	1/8"	Square	1/2"

DESK

Part No.	Wall Thickness	Corner ID	Frame Depth
311	1/16"	Round (3/8", 1/2", 9/16", 13/16")	3/8" or 1/2"
211	1/16"	Square	3/8" or 1/2"
611	1/8"	Round (3/8", 1/2", 9/16", 13/16")	1/2"
511	1/8"	Square	1/2"

Maximum sign height 4".

Please specify part number, inside dimension, inside depth, and color. Prices are for frames up to 100 perimeter inches. Please request quote for larger frames.

All holders and frames can be combined for quantity discounts.

See price list for current pricing and quantity discounts.

ARCHITECTURAL ALUMINUM FRAMES

COUNTER

Part No.	Wall Thickness	Corner ID	Frame Depth
321 Single	1/16"	Round (3/8" , 1/2", 9/16", 13/16")	3/8" or 1/2"
322 Double	1/16"	Round (3/8" , 1/2", 9/16", 13/16")	3/8" or 1/2"
221 Single	1/16"	Square	3/8" or 1/2"
222 Double	1/16"	Square	3/8" or 1/2"
621 Single	1/8"	Round (3/8" , 1/2", 9/16", 13/16")	1/2"
622 Double	1/8"	Round (3/8" , 1/2", 9/16", 13/16")	1/2"
521 Single	1/8"	Square	1/2"
522 Double	1/8"	Square	1/2"

Maximum sign height - 10"

CORRIDOR

Part No.	Wall Thickness	Corner ID	Frame Depth
361 Single	1/16"	Round (3/8" , 1/2", 9/16", 13/16")	3/8" or 1/2"
362 Double	1/16"	Round (3/8" , 1/2", 9/16", 13/16")	3/8" or 1/2"
261 Single	1/16"	Square	3/8" or 1/2"
262 Double	1/16"	Square	3/8" or 1/2"
661 Single	1/8"	Round (3/8" , 1/2", 9/16", 13/16")	1/2"
662 Double	1/8"	Round (3/8" , 1/2", 9/16", 13/16")	1/2"
561 Single	1/8"	Square	1/2"
562 Double	1/8"	Square	1/2"

Minimum height 2".

CEILING

Part No.	Wall Thickness	Corner ID	Frame Depth
371 Single	1/16"	Round (3/8" , 1/2", 9/16", 13/16")	3/8" or 1/2"
372 Double	1/16"	Round (3/8" , 1/2", 9/16", 13/16")	3/8" or 1/2"
271 Single	1/16"	Square	3/8" or 1/2"
272 Double	1/16"	Square	3/8" or 1/2"
671 Single	1/8"	Round (3/8" , 1/2", 9/16", 13/16")	1/2"
672 Double	1/8"	Round (3/8" , 1/2", 9/16", 13/16")	1/2"
571 Single	1/8"	Square	1/2"
572 Double	1/8"	Square	1/2"



Counter

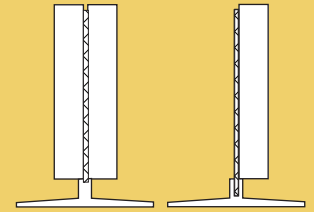

Corridor

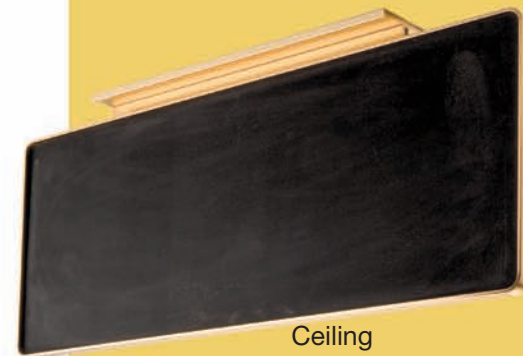
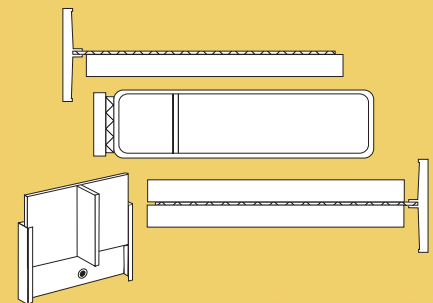

Ceiling

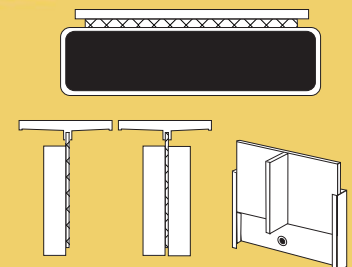

ARCHITECTURAL ALUMINUM FRAMES

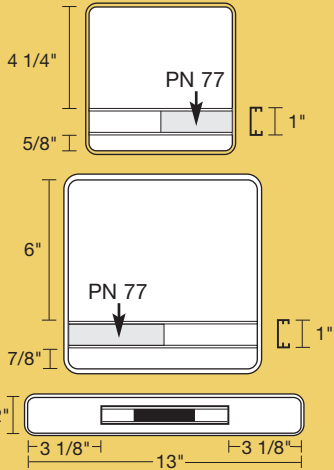

CHANGEABLE MESSAGE FRAMES

Special requirements for room control and identification are accomplished with these unique frames of anodized aluminum.

- Both 1/16" wall and 1/8" wall frames have 1/2" outside depth plus 1/8" backer and 3/16" inside depth.
- Frames sizes are all inside dimensions.
- Nine standard colors: Polished Yellow Gold, Polished Silver, Matte Black, Satin Silver, Arch Bronze, JRS Bronze, Polished Rose Gold, Satin Rose Gold and Satin Yellow Gold.
- All frames on this page are available in custom sizes. Please request quote.
- 6" x 6" frame containing a 1" x 6" extrusion for a 1/16" message plate and a secondary 1/16" slot for a 1" x 3" sliding plate to uncover alternating messages.

	3/8" Inside Radius Corner	Square Corner
6" x 6"		
1/16" wall	341-66	241-66
1/8" wall	641-66	541-66
8" x 8"		
1/16" wall	341-88	241-88
1/8" wall	641-88	541-88
2" x 13"		
1/16" wall	344-23	244-23
1/8" wall	644-23	544-23

- 8" x 8" frame containing a 1" x 8" extrusion for a 1/16" message plate and a secondary 1/16" slot for a 1" x 4" sliding plate to uncover alternating messages.
- 2" x 13" Slider Frame is designed for 2" x 10" message plates to slide left or right to expose message at opposite end.

DIVIDED FRAMES AND MINI-DIRECTORIES

All frames are available with dividers in either horizontal, vertical, or both horizontal and vertical positions. These frames must have a backer plate.

To price frames, simply add the total of the perimeter inches to the total of the dividers and multiply that total by the cost per inch of the particular frame type ordered. Divider frames should be ordered by giving the inside dimension of each section.

Overall frame size is increased by the thickness of each divider within the frame.

- 6" x 6" Mini-Directory features a one piece magnetic backed extrusion with six 1/2" x 6" slots for easy plate changes.
- 8" x 8" Mini-Directory features a one piece magnetic backed extrusion with seven 5/8" x 8" slots for easy plate changes.

Divider Frames

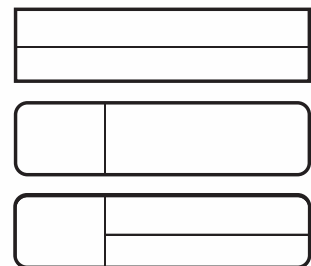

Divided Frames and Mini-Directories

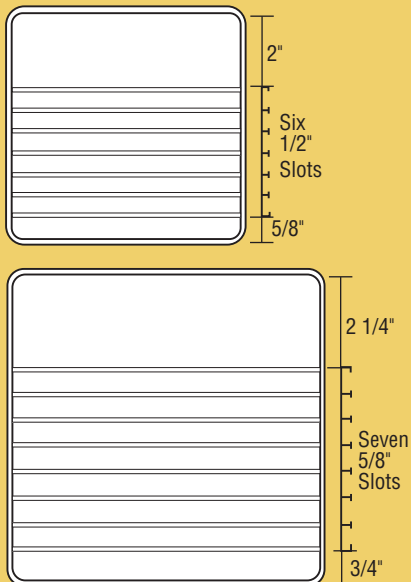

Mini-Directories

	3/8" Inside Radius Corner	Square Corner
6" x 6"		
1/16" wall	342-66	242-66
1/8" wall	642-66	542-66
8" x 8"		
1/16" wall	343-88	243-88
1/8" wall	643-88	543-88

ARCHITECTURAL ALUMINUM FRAMES

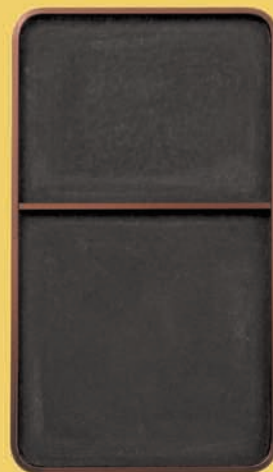
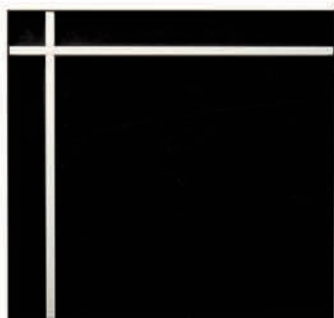

CUSTOM SHAPED FRAMES

Circles, Triangles, Ovals, Half Round Directories and more are available in our 300 (1/16" wall) or 600 (1/8" wall) Aluminum Extrusion Frames. Frames with custom shapes with or without dividers are fabricated to your specifications in all of our standard anodized and powder coat finishes. Please send drawings with size specifications, finish and quantity for quotation via fax.

Please specify part number, inside dimension, inside depth, and color. Prices are for frames up to 100 perimeter inches. Please request quote for larger frames.

All holders and frames can be combined for quantity discounts.

See price list for current pricing and quantity discounts.

**CALL US WITH
YOUR CUSTOM
FABRICATION
NEEDS.
WE CAN HELP!**

HEAVY ARCHITECTURAL SIGNAGE



This line of frames is fabricated from a heavy 1/8" thick wall and 1 3/4" or 1 1/4" wide extrusions. They can be used either as a double or single sided frame for counters, desks or walls. All frames are custom fabricated to your specifications. Sharp clean square corners are fabricated from continuous extrusion.

- Frames are available in nine anodized finishes: Polished Rose Gold, Polished Yellow Gold, Polished Silver, Arch Bronze, JRS Bronze, Matte Black, Satin Silver, Satin Rose Gold and Satin Yellow Gold.

- Not available in Powder Coat finishes.
- All frames are available with optional Matte Black metal inside suitable for changeable magnetic signs (up charge applies).
- Please specify part number, inside dimension, inside depth, and color.
- Net price is calculated by multiplying the perimeter inch price by the perimeter inches of the frame.

Example: a 932D frame:

$$2" \times 8" = 2 + 8 + 2 + 8 = 20 \text{ perimeter inches.}$$

$$20 \text{ perimeter inches} \times \text{price per inch} = \$\text{Net Cost}$$

Part No.	Frame Thickness	Inside Depth
932D Double Sided	1 3/4"	5/16"
932S Single Sided	1 3/4"	5/16"
942D Double Sided	1 1/4"	5/16"
942S Single Sided	1 1/4"	5/16"

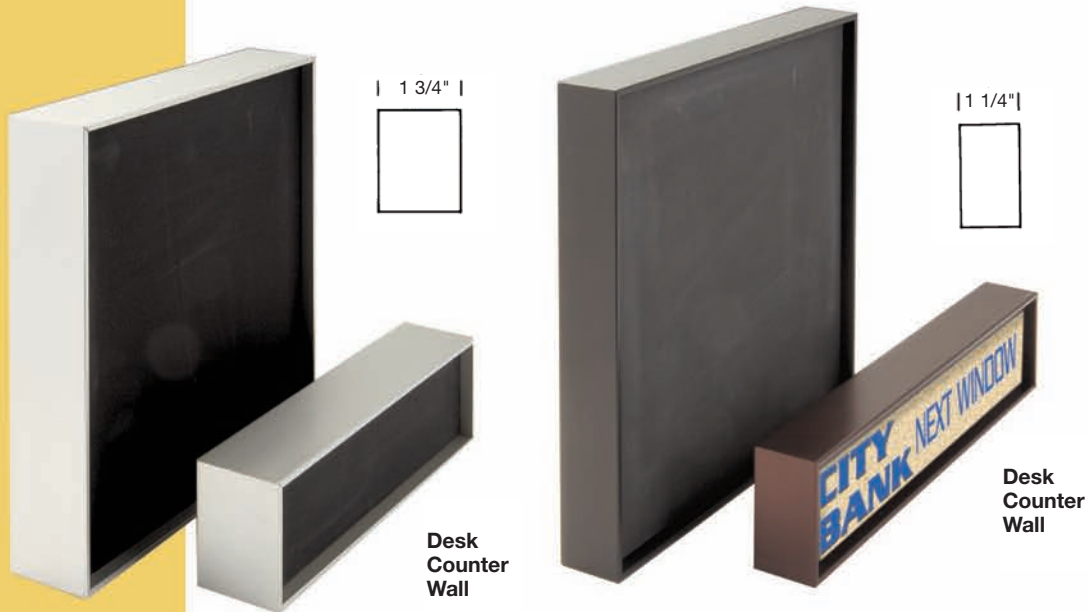

Please specify part number, inside dimension, inside depth, and color.

All holders and frames can be combined for quantity discounts.

See price list for current pricing and quantity discounts.

ARCHITECTURAL SIGN BASES AND FRAME SUPPLIES

SIGN BASES

Architectural sign holders, designed in contemporary styles, come in a variety of shapes and sizes. Holders are highly polished and anodized in Polished Rose Gold or Polished Silver, enhancing any decor. Styles and sizes are indicated by part number and length. Custom lengths and three custom colors, Matte Black, Satin Silver, and Polished Yellow Gold are available by special order at no extra cost. Arch Bronze, JRS Bronze, Satin Yellow Gold, and Satin Rose Gold are also available upon request for a 25% up charge and up to 4 week delivery. *Mounting Plate for Corridor and Ceiling Brackets conceal mounting screws.*

Part No.	A	Size	B	Maximum Sign Height
72	2 1/8"		1/8"	
73	2"		1/8"	12" No Holes
74	1 1/2"		1/8"	5"
111	1 1/2"		1/8"	4"
200	2"			12"
294	2 1/8"			12"

FRAME SUPPLIES

THIN TIN

Thin tin for mounting sign magnetically .010 thick with adhesive back and black paper coated front surface. Thin tin can be cut with shears or industrial scissors. See price guide for pricing.

BLACK STYRENE

Black styrene with unfinished surfaces is used as filler material. See price guide for pricing.

BLACK ABS AIR CELL BLACK

Tough durable Air Cell finish on one side used for backing material.

Part No.	Product	Thickness	Sheet Size (approx)
B02140	Thin Tin	.010	21" x 40"
B02116	Black Styrene	1/16"	24" x 48"
B02118	Black ABS	1/8"	24" x 48"

FRAME EXTRUSIONS

Part No.	Size	Lengths			
202	six 1/2" x 1/16" slots	6"	8"	10"	36"
203	seven 5/8" x 1/16" slots	6"	8"	10"	36"
206	one 4 13/16" x 1/16" slots	6"	8"	10"	36"

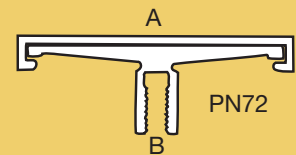

PN73 + PN 94 = PN 72

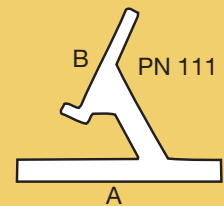
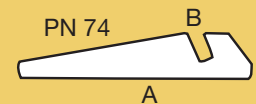
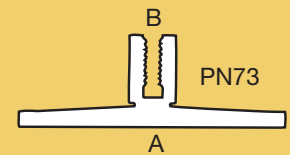

Double sided tape or adhesive is required for sign installation.

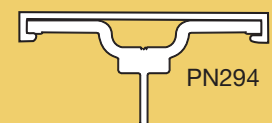
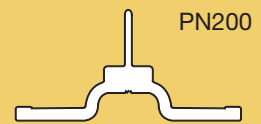

PN 200 + PN 94 = PN 294

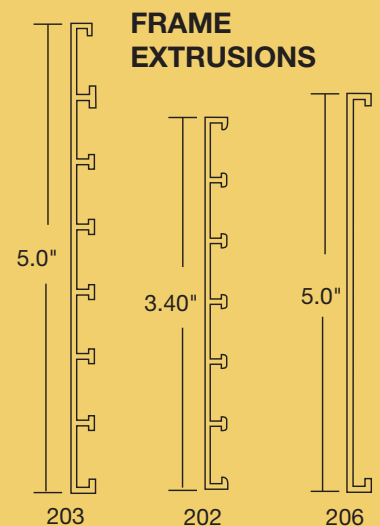

DECORATIVE BARS

Four sizes of decorative bars create bold metallic borders for your signs. Formats of top and bottom or left side, right side are available. One can use equal size bars or mix two different sizes. All three sizes can be made into a complete four-sided frame.

2", 1 1/2", 1" and 5/8" profiles are polished and anodized from premium aluminum for rich metallic finishes.



Acrylic lenses are laser cut and snap into frames over paper graphics.

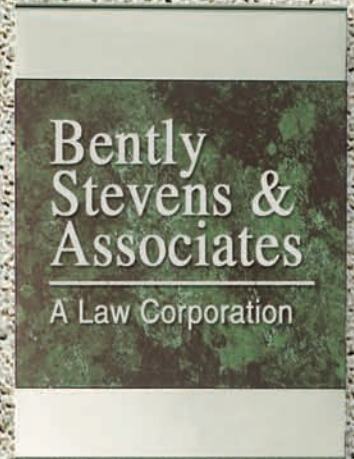

DECORATIVE BARS

Four sizes of decorative bars create bold metallic borders for your signs. Standard format of top and bottom bars will be manufactured unless left side, right side bars are specified. Use same size bar or mix two different sizes for a unique look. When ordering specify bar size.

- All four sizes can be made into a complete four sided frame.
- Bars are available in five anodized finishes: Satin Silver, and Matte Black are standard. Polished Silver, Polished Rose Gold and Polished Yellow Gold are available for a 25% upcharge. All parts are anodized individually to give finished ends.
- Please specify part number, inside dimension and color. Inside depth is 1/4" unless specified. Not all formats accommodate a lens.
- Fax for quote on frames over 100 perimeter inches.
- Divided frames available. Maximum 2 dividers per each frame.
- **Not all formats accommodate a lens.**

Part No.	Size
213	5/8"
214	1"
215	1 1/2"
216	2"
2132	5/8"
2142	1" bar
2152	1 1/2" bar
2162	2" bar
2134	5/8"
2144	1" bar
2154	1 1/2" bar
2164	2" bar

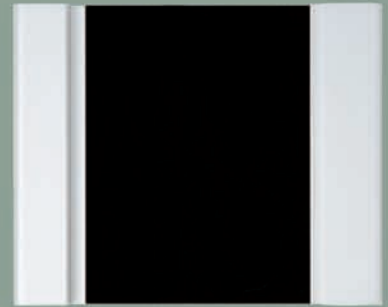
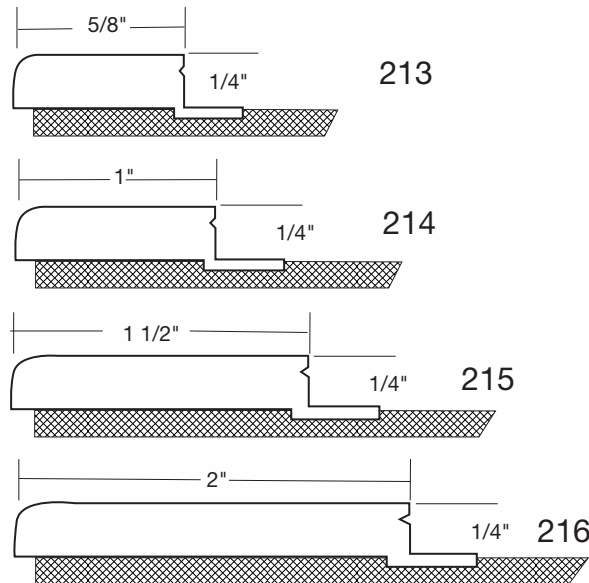

Two Sided Frames
2132, 2142, 2152, 2162

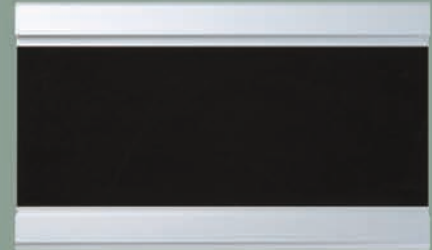

Four Sided Frames
2134, 2144, 2154, 2164



Please specify part number, inside dimension, inside depth, and color. Prices are for frames up to 100 perimeter inches. Please request quote for larger frames.

All holders and frames can be combined for quantity discounts.

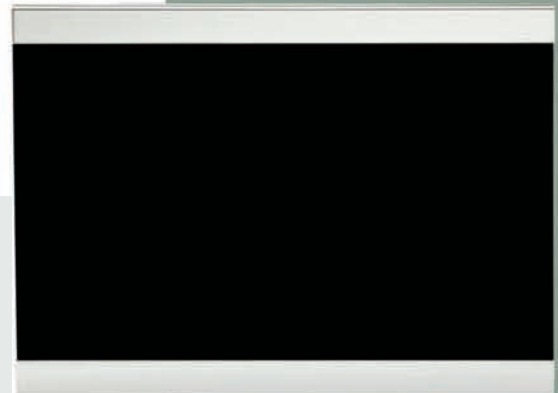

LENSES

Lenses are made of a semi-flexible .060 or .080 non-glare acrylic and designed with tabs that snap the lens securely into the frame.

Lenses snap out by the use of a suction cup placed in the center of the lens. Maximum lens size is 200 square inches.

Net price of lens is calculated by total square inches.

See price list for current pricing

CHROME PLATED BARS

Chrome plated bars add brilliance and prestige for those looking for the ultimate finish. Available in a Bright Chrome finish. Please contact us for lead times and pricing.

CURVES *Curved Face Sign Frames*

Curves adds a whole new dimension to sign frames. Available in 9 anodized colors, Curves has many applications including personnel signs, room identification and direction wayfinding signs. Curves can be mounted to a wall or partition, hung from the ceiling with fixed bracket or wire, flag mounted or used as a desk signholder... CURVES...literally, the options end only with your imagination!



Insert Removal

Front loaded modular insert facilitates easy removal with suction cup tool.



CURVES

Curved Face Sign Frames

FLEXIBLE...SIMPLE...EASY

What happens when you combine the simple easy to use aspects of our Traditional Holder line with the flexible nature of our Custom Frame lines? You get Curves! Innovative and cost effective.

FEATURES

- 9 Anodized Color Choices
- Tamper Resistant
- Custom Sizing Available
- Uses 1/16" Engraving Material
- Can use a Lens with paper insert

TYPICAL USES

- Personnel Signs
- Room Identification
- Point of Purchase
- Directional Ceiling and Wall Signage
- Directories

Manufactured from premium alloy with either molded or custom fabricated end cap, Curves has many applications including: personnel signs, room identification sign and directional wayfinding signs. Curves can be mounted to a wall or partition, hung from the ceiling with a fixed bracket or wire, flag mounted or used as a desk sign holder. Literally, the options end only with your imagination.



CURVES



NOTE: 1/32" material for lens will be used on frames 4" and under.

CURVES



Hanging Ceiling Sign



Flush Ceiling Mount



Flag Mount

Some size restrictions on Flag Mount. Call for details.

Part No	PART WIDTH WIDTH A	INSERT MATERIAL THICKNESS B
229	2 1/2"	1/16"
229L	Frame With Lens	
229F1	Single Sided Flag Mount	
229F2	Double Sided Flag Mount	
229C1	Single Sided Hanging Ceiling	
229C2	Double Sided Hanging Ceiling	
229C3	Single Sided Flush Mount Ceiling	
229C4	Double Sided Flush Mount Ceiling	
230	4"	1/16"
230L	Frame With Lens	
230F1	Single Sided Flag Mount	
230F2	Double Sided Flag Mount	
230C1	Single Sided Hanging Ceiling	
230C2	Double Sided Hanging Ceiling	
230C3	Single Sided Flush Mount Ceiling	
230C4	Double Sided Flush Mount Ceiling	
231	6"	1/16"
231L	Frame With Lens	
231F1	Single Sided Flag Mount	
231F2	Double Sided Flag Mount	
231C1	Single Sided Hanging Ceiling	
231C2	Double Sided Hanging Ceiling	
231C3	Single Sided Flush Mount Ceiling	
231C4	Double Sided Flush Mount Ceiling	
232	8"	1/16"
232L	Frame With Lens	
232F1	Single Sided Flag Mount	
232F2	Double Sided Flag Mount	
232C1	Single Sided Hanging Ceiling	
232C2	Double Sided Hanging Ceiling	
232C3	Single Sided Flush Mount Ceiling	
232C4	Double Sided Flush Mount Ceiling	
233-811	8 1/2 X 11	1/16"
232-811L	Frame With Lens	
232-811F1	Single Sided Flag Mount	
232-811F2	Double Sided Flag Mount	
232-811C1	Single Sided Hanging Ceiling	
232-811C2	Double Sided Hanging Ceiling	
232-811C3	Single Sided Flush Mount Ceiling	
232-811C4	Double Sided Flush Mount Ceiling	
233-814	8 1/2 X 14	1/16"
232-814L	Frame With Lens	
232-814F1	Single Sided Flag Mount	
232-814F2	Double Sided Flag Mount	
232-814C1	Single Sided Hanging Ceiling	
232-814C2	Double Sided Hanging Ceiling	
232-814C3	Single Sided Flush Mount Ceiling	
232-814C4	Double Sided Flush Mount Ceiling	

CURVES

Part No	PART WIDTH WIDTH A	INSERT MATERIAL THICKNESS B
233-117	11 X 17	1/16"
232-117L	Frame With Lens	
232-117F1	Single Sided Flag Mount	
232-117F2	Double Sided Flag Mount	
232-117C1	Single Sided Hanging Ceiling	
232-117C2	Double Sided Hanging Ceiling	
232-117C3	Single Sided Flush Mount Ceiling	
232-117C4	Double Sided Flush Mount Ceiling	
CU-CUST	CUSTOM SIZE CURVE FRAME	

Frame price includes standard black end caps and screws.

Final customer assembly is required.

All holders and frames can be combined for quantity discounts.

SEE PRICE LIST FOR CURRENT PRICING AND QUANTITY DISCOUNTS.

INJECTION MOLDED & ALUMINUM END CAPS



End Caps and
Screws
available in
BL, GR, metal.

Part No.	Size	Color Options (Please specify)	
CAP2.5	2 1/2"	GRAY OR BLACK	2 End Caps + Screws
CAP4	4"	GRAY OR BLACK	2 End Caps + Screws
CAP6	6"	GRAY OR BLACK	2 End Caps + Screws
CAP8	8"	GRAY OR BLACK	2 End Caps + Screws
CAP8.5	8 1/2"	GRAY OR BLACK	2 End Caps + Screws
CAP9	9"	GRAY OR BLACK	2 End Caps + Screws
CAP10	10"	GRAY OR BLACK	2 End Caps + Screws
CAP11	11"	GRAY OR BLACK	2 End Caps + Screws
CAP12	12"	GRAY OR BLACK	2 End Caps + Screws

IMPORTANT ORDERING NOTES:

- When ordering specify Part No and length wanted (for example 229-08, is a 2 1/2 x 8" frame)
- When ordering with specific Frame Options, simply add suffix to the end of the Part No (229-08L, is a 2 1/2 x 8" frame with lens)
- Max length extending from the wall on a Flag Mounted Frame will vary with Part No, please contact us with Flag Mounted frames exceeding 12" in length - Please supply a drawing for Flag Mounted Frames to insure accuracy
- Custom End Width from 8" to 24" is available - contact us for a special quote on frames of this size
- First number denotes end cap width (for example a frame that is 10" x 2" would have a 10" end cap width and arc)
- Accommodates 1/16" engraving material
- Accommodates .060 lens or .030 lens
- Pricing includes end caps and screws, not assembled (frames may be assembled for a nominal charge)
- Holes are not standard - please request on order to have holes



FRAMES WITH LENSES

Matte clear acrylic based lenses are laser cut to snap in and out of anodized aluminum frames, round or square cornered. Lenses can be screen-printed and have tactile or Braille mounted to them while exposing a paper graphic.



Acrylic lenses are laser cut and snap into metal frames over paper graphics. Lenses can be screened or have tactile and Braille characters mounted to them.

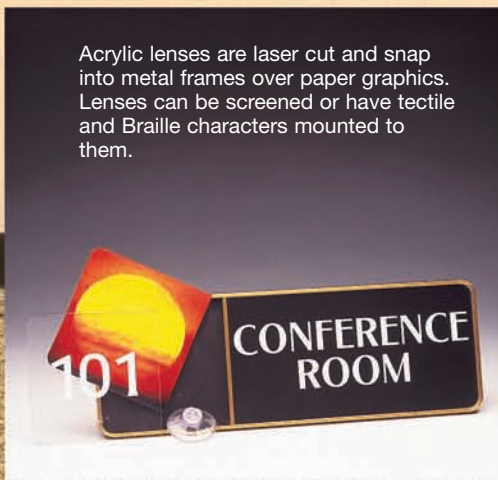

ALUMINUM FRAMES WITH LENSES

SNAP IN LENSES are designed for custom size aluminum frames in sizes from 6 to 200 square inches.

- Frames have 1/8" wall thickness, 7/16" outside depth, 3/16" inside depth with a 1/8" masonite backer.
- Lenses snap in and out with the aid of a suction cup placed in the center of the lens.
- Dividers are used to make multi-lens compartments.
- Special matte black dividers can be used to make compartments under a single lens.
- Frames can be made to accommodate paper and 1/32", 1/16", or 1/8" sign material.
- Frames are available in nine anodized finishes: Polished Rose Gold, Polished Yellow Gold, Polished Silver, Arch Bronze, JRS Bronze, Matte Black, Satin Silver, Satin Rose Gold, and Satin Yellow Gold.
- Please specify part number, inside dimension, color, and sign material thickness.
- Prices are for frames up to 100 perimeter inches. Please request quote on larger frames.

DOOR OR WALL

- 140 Square Corner
940 Round Corner
3/8" inside radius

DESK

- 141 Square Corner
941 Round Corner,
3/8" inside radius

Net price is calculated by multiplying the perimeter inch price by the total perimeter inches of the frame.

Example: Part #140 2" x 8" = 2 + 8 + 2 + 8 = 20 perimeter inches.

20 perimeter inches x price per perimeter inch = Net Price

LENSES

Lenses are made of a semi-flexible .060" or .080" non glare acrylic designed with tabs that snap the lens securely into the frame. Lenses snap out by the use of a suction cup. Maximum lens size is 200 square inches.

Net price of lenses is calculated by total square inches.

Add frame cost and lens cost together. Treat frame and lens as one unit for quantity discount.

HOLES BY REQUEST ONLY

Please specify part number, inside dimension, inside depth, and color. Prices are for frames up to 100 perimeter inches. Please request quote for larger frames.

All holders and frames can be combined for quantity discounts.

See price list for current pricing and quantity discounts.

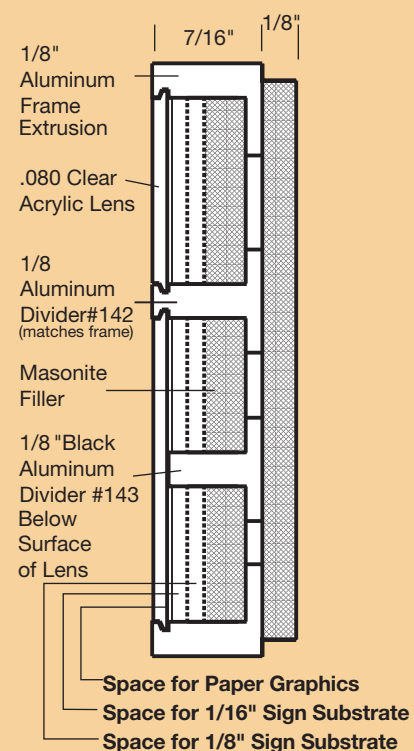

940

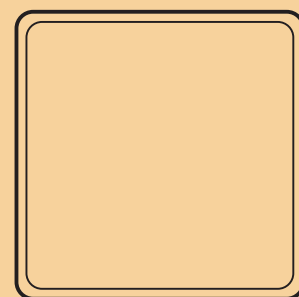

140

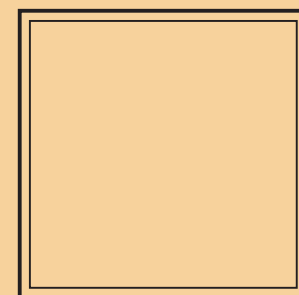

XTERIOR

Precision mitered from a premium aluminum alloy, XTERIOR is suitable for outdoor applications. Available in two 'Hard-coat' anodized colors, **Satin Yellow Gold** and **Satin Silver**, each frame is hand assembled utilizing stamped stainless steel corner angles. Typical usages include, departmental signage, directional/wayfinding signage and informational signage.

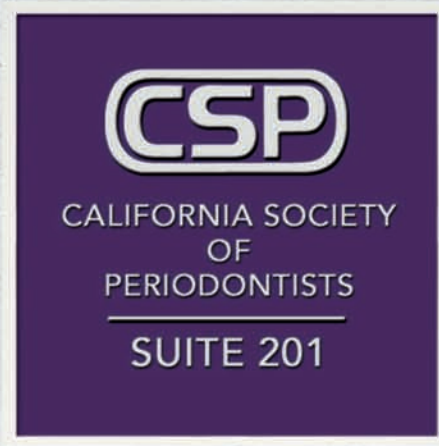

Xterior

OUTDOOR FRAMES

- Frames designed to accommodate materials with thicknesses of 1/16" to 5/16".
- Minimum size 3" x 3".
- Maximum size 36" x 36".
- Anodized colors: Satin Yellow Gold or Satin Silver – hardcoat finish adds durability to the wear of the frame material.
- Mounting Options: double sided tape, silicon adhesive, mechanically fastened (recommended). Mounting hardware is not included.
- Holes provided upon request.

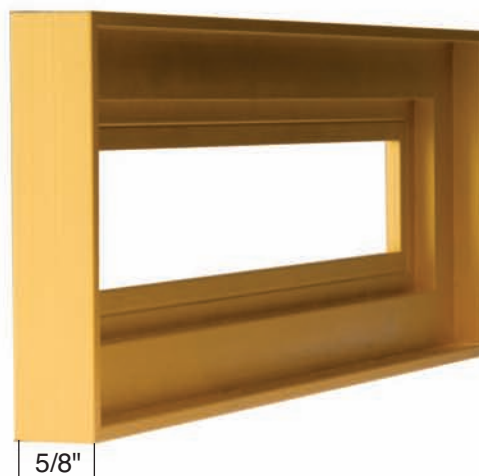

B3
STAIR B3
COX
INVESTMENT
GROUP

E-Z SIGN KITS

E-Z Signs

Create signs from any desktop computer using our E-Z Sign system. Simple user-friendly templates can be downloaded from the Web and within minutes you can be printing your own signs on our custom perforated sheets using your own word processing program. Perfectly suited for temporary signs, often-changed signs, informational signs or conference rooms. With the E-Z Sign system, your options are endless.

FEATURES:

- FREE easy to use downloadable templates
- High quality paper inserts
- Quality JRS plastic frames and lenses
- Round or square corners
- Wall, desk or partition mountable
- 13 Popular sizes
- 6 Popular frame colors
- Affordable

USAGES:

- Meeting room agendas
- Conference room
- Evacuation plans
- Door and desk signs
- Department signs
- Room number signs
- Daily menus

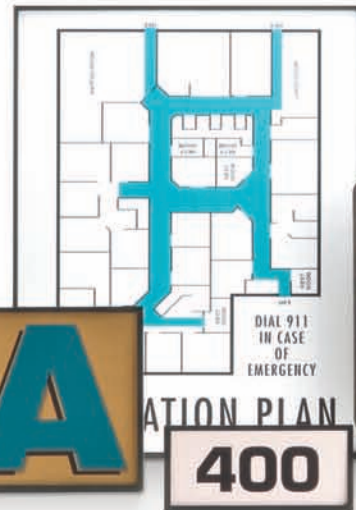

All holders and frames can be combined for quantity discounts.

See price list for current pricing and quantity discounts.

E-Z SIGN KITS

FRAMES

The 5000 series round corner and 6000 series square corner molded plastic frames are designed for quality interior signage. Each frame is molded in one of 6 matte colors: Gray, Almond, White, Brown, Arch Brown, and Black. All frames have a 1/2" outside depth, 1/8" thick walls, and mounting holes for attaching to walls. The inside radius on the round corner frames is 5/16".

Part No.	Frame Size	Corner	Signs/Each Sheet
5166	6 1/8" x 6 1/8"	Round	1
6166	6 1/8" x 6 1/8"	Square	1
5144	4 1/8" x 4 1/8"	Round	2
6144	4 1/8" x 4 1/8"	Square	2
5169	6 1/8" x 9 1/8"	Round	1
6169	6 1/8" x 9 1/8"	Square	1
5149	4 1/8" x 9 1/8"	Round	1
6149	4 1/8" x 9 1/8"	Square	1
5129	1 3/4" x 9 1/8"	Round	3
6129	1 3/4" x 9 1/8"	Square	3
5124	1 3/4" x 4 1/8"	Round	8
6124	1 3/4" x 4 1/8"	Square	8
6181	8 1/2" x 11"	Square	1

Each set includes 1 frame with lens, 1 sheet of perforated sign paper and a suction cup tool.

7500 Base snaps into the 1 3/4" x 9 1/8" frame (both round or square) making a desk or counter unit.

Part No.	Size
7500	Desk Base for 5129 & 6129
Paper	Specify Frame Part No. (sold in sets of 10)
P110	Partition Hanger

Attach a frame to a P110 for easy cubicle mounting.

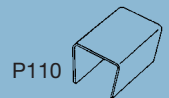
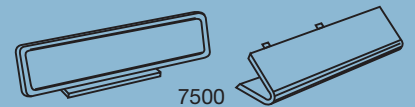
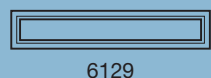
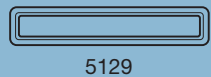
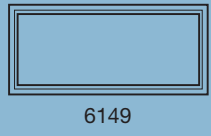
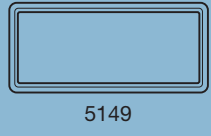
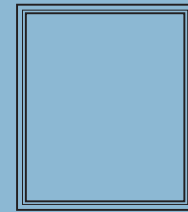

ARCHITECTURAL FRAMES

In Molded Plastic

Architectural Frames in Molded Plastic is a round and square corner system designed for quality interior signage. Nine different sizes can be interchanged to enhance any interior. The six colors offered are PEWTER GRAY, ALMOND, BROWN, ARCH BROWN, BLACK AND WHITE.



WINDOW
LENS NOT
AVAILABLE



Plates will snap out of frames for easy changes with the use of a suction cup.



Acrylic lenses are laser cut and snap into frames featuring paper graphics.



A black anodized aluminum bracket with concealed screws is used to mount double sided frames.

ARCHITECTURAL FRAMES, PLATES & LENSES

The 7000 series round corner and 8000 series square corner molded plastic frames are designed for quality interior signage. Each frame is molded in one of 6 matte colors: **PEWTER GRAY, MEDIUM GRAY, ALMOND, WHITE, BROWN, ARCH BROWN, AND BLACK.** All frames have a 1/2" outside depth, 1/8" thick walls and mounting holes for attaching to walls. The size of each frame is listed as an inside dimension and the inside radius on the round corner frames is 5/16". Each frame is designed to accommodate all sign material from 1/16" to 1/8" thick, or it's own plastic injected molded plate (See next page).

Part No.	Inside Dimension	Corner
7199	9 1/8" x 9 1/8"	Round
8199	9 1/8" x 9 1/8"	Square
7166	6 1/8" x 6 1/8"	Round
8166	6 1/8" x 6 1/8"	Square
7144	4 1/8" x 4 1/8"	Round
8144	4 1/8" x 4 1/8"	Square
7143	4 1/8" x 13 1/8"	Round
8143	4 1/8" x 13 1/8"	Square
7169	6 1/8" x 9 1/8"	Round
8169	6 1/8" x 9 1/8"	Square
7149	4 1/8" x 9 1/8"	Round
8149	4 1/8" x 9 1/8"	Square
7129	1 3/4" x 9 1/8"	Round
8129	1 3/4" x 9 1/8"	Square
7124	1 3/4" x 4 1/8"	Round
8124	1 3/4" x 4 1/8"	Square
8181	8 1/2" x 11"	Square Only

All holders and frames can be combined for quantity discounts.

See price list for current pricing and quantity discounts.



7500 BASE snaps into the 1 3/4" x 9 1/8" frame (both round or square) making a desk or counter unit. Base is 6"

FRAMES WITH LENSES

Each frame size in both round or square corner is available with an .080 semi-flexible non-glare acrylic lens. Lenses are laser cut with small tabs that snap into frames. Lenses can be painted, screen printed, engraved or have tactile and braille attached to them. Each frame is supplied with a snap in lens and a matte black backing insert.

**Custom colors available.
Call for details.**

ARCHITECTURAL PLATES *In Molded Plastic*

Color Swatches



Gray/Gray
Gray/Black
Gray/White
Gray/Arch Brown



Almond/Black
Almond/Brown
Almond/Arch Brown
Almond/Almond



Brown/Brown
Brown/Almond
Almond/White
Arch Brown/Arch
Brown
Arch Brown/Almond
Arch Brown/White



Black/Black
Black/Almond
Black/Gray
Black/White
Red/White
Blue/White
Burgundy/White
Burgundy/Gray



White/White
White/Black
Brushed Gold/Black
Brushed Silver/Black



Teal/White
Teal/Gray
Teal/Almond



Mauve/White
Mauve/Gray
Mauve/Almond



Colors are only representative. Request a color keychain for exact color.

MOLDED PLATES FOR ARCHITECTURAL FRAMES

Molded plates are 1/8" thick with a 1/16" reveal around the perimeter leaving a handsome border. Each plate is designed to snap in and out of respective frames for changeable signs, or can be permanently mounted with two sided tape. Plates are molded in the same six colors as the frames and then are stamped with a tough durable matte finish suitable for hot stamping, vinyl letters, or silk screening. For 2 ply engraving, 6 core colors and 13 surface colors can be combined for a quality contrasting engraved plate.

Molded Part No.	Laser Part No.	Plate Size	Corner
7299	5299	9 1/8" x 9 1/8"	Round
8299	6299	9 1/8" x 9 1/8"	Square
7266	5266	6 1/8" x 6 1/8"	Round
8266	6266	6 1/8" x 6 1/8"	Square
7244	5244	4 1/8" x 4 1/8"	Round
8244	6244	4 1/8" x 4 1/8"	Square
7243	5243	4 1/8" x 13 1/8"	Round
8243	6243	4 1/8" x 13 1/8"	Square
7249	5249	4 1/8" x 9 1/8"	Round
8249	6249	4 1/8" x 9 1/8"	Square
7229	5229	1 3/4" x 9 1/8"	Round
8229	6229	1 3/4" x 9 1/8"	Square
7224	5224	1 3/4" x 4 1/8"	Round
8224	6224	1 3/4" x 4 1/8"	Square
7269	5269	6 1/8" x 9 1/8"	Round
8269	6269	6 1/8" x 9 1/8"	Square
	6281	8 1/2" x 11"	Square

LASERABLE ARCHITECTURAL PLATES in popular colors

Plates suitable for use with Laser Engraving equipment. Plates are 1/16" thick and are designed to snap in and out of their respective frames.



Available color combinations include:

Top Color/Core Color

Red/White
Blue/White
Black/White
Green/White
Navy/White
Burgundy/White
Brown/White
Pine Green/White
Teal/White
Medium Walnut/White
Charcoal Marble/White

Verde Green Marble/White
Cranberry Marble/White
Rustico Granite/White

White/Black
Yellow/Black
Pumice/Black
Platinum Marble/Black
Brushed Gold/Black
Brushed Aluminum/Black

BLACK	RED	BLUE
WHITE	WHITE	WHITE
GREEN	NAVY	BURGUNDY
WHITE	WHITE	WHITE
MEDIUM WALNUT	TEAL	PINE GREEN
WHITE	WHITE	WHITE
CHARCOAL MARBLE	CRANBERRY MARBLE	RUSTICO GRANITE
WHITE	WHITE	WHITE
VERDE GREEN MARBLE	WHITE	YELLOW
WHITE	BLACK	BLACK
PUMICE	BRUSHED GOLD	BRUSHED ALUMINUM
BLACK	BLACK	BLACK

ARCHITECTURAL FRAMES *In Molded Plastic*

DESK BARS

Desk Bars are designed as a simple architectural nameplate holder or counter sign. They are 1" thick and have an inside dimension of 1 3/4" x 9 1/8" to accommodate our injected molded plate. The desk bar is also available in **WHITE, PEWTER GRAY, ALMOND, BROWN, ARCH BROWN, AND BLACK.**

Jonathan Q. Smith
General Manager

Part No.	Inside Dimension	Corner
7029	1 3/4" x 9 1/8"	Round
8029	1 3/4" x 9 1/8"	Square

All holders and frames can be combined for quantity discounts.

See price list for current pricing and quantity discounts.

CORRIDOR FRAMES WITH BRACKETS

Anodized black aluminum bracket conceals screws while mounting a double sided corridor frame.

Corridor frames are custom and non-returnable.

Part No.	Plate Size	Corner
7329	1 3/4" x 9 1/8"	Round
8329	1 3/4" x 9 1/8"	Square
7366	6 1/8" x 6 1/8"	Round
8366	6 1/8" x 6 1/8"	Square
7399	9 1/8" x 9 1/8"	Round
8399	9 1/8" x 9 1/8"	Square
7343	4 1/8" x 13 1/8"	Round
8343	4 1/8" x 13 1/8"	Square

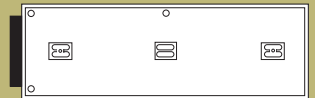
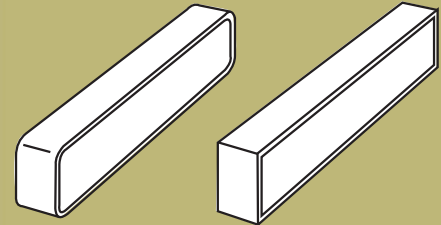

Inside of frame is not a flat surface. Raised pegs inside.

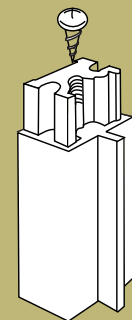

Mount to Wall

Mounts to Plate

ARCHITECTURAL FRAMES IN MOLDED PLASTIC have many uses

and provide a quality, inexpensive solution to your interior signage needs. On this page are some examples of the many ways in which are Architectural Plastic Frames can be used.

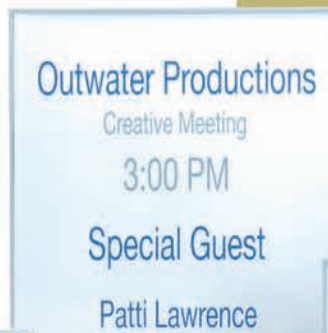

DESIGNER FRAMES *In Molded Plastic*

The Designer Series is a round corner plastic molded sign system with features created to solve your many sign requirements. It is available in 10 different sizes, all with round corners and 6 matte colors: **PEWTER GRAY, MEDIUM GRAY, BLACK, WHITE, ALMOND AND BROWN.**

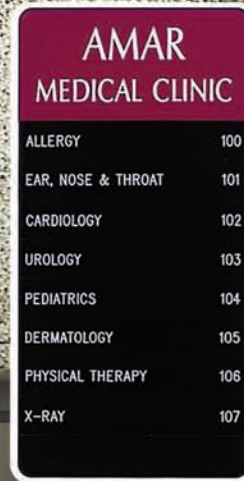

Sign Snap extrusion fasteners snap plates in and out with the use of a suction cup.

Frame dividers section off frames for multiple plates.



Designer frames have keyhole mounts or wire clips for mounting to fabric covered partitions.



DESIGNER FRAMES *In Molded Plastic*

Our DESIGNER FRAME SYSTEM is designed for quality interior signage. Several unique features offered by this system will make designing and mounting interior signage simple.

- Ten sizes in six colors: Pewter Gray, White, Medium Gray, Almond, Brown, and Black.
- Completely supports 1/16" & 1/8" material so that multiple plates can be used as mini-directories or divided sign messages.
- Plates can be mounted with adhesive-backed 3M DUAL LOCK™ or Sign Snap so that they are tamper resistant but still removable with a suction cup.
- Plates can be permanently mounted to inside of frames with adhesives or two sided transfer tape.
- Keyhole mounting for permanent or removable frames.
- Pin system that mounts into a frame for hanging frames from fabric office partitions.
- Base that snaps into a 9120 and 9128 frame for a handsome desk sign.
- Double sided frames with corridor bracket. Corridor bracket mounts with two piece bracket for concealed screws.

Part No.	Inside Dimension
9120	1 7/8" x 9 7/8"
9128	1 7/8" x 7 7/8"
9000	6" Desk Base for 9128 and 9120 frames
9122	11 7/8" x 11 7/8"
9188	7 7/8" x 7 7/8"
9166	5 7/8" x 5 7/8"
9144	3 7/8" x 3 7/8"
9162	5 7/8" x 11 7/8"
9142	3 7/8" x 11 7/8"
9148	3 7/8" x 7 7/8"
9124	1 7/8" x 3 7/8"

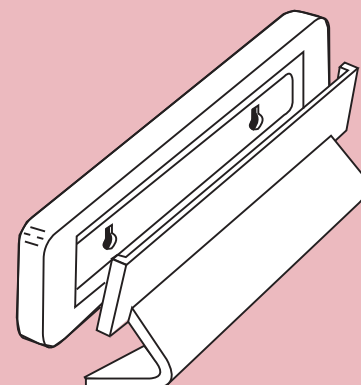
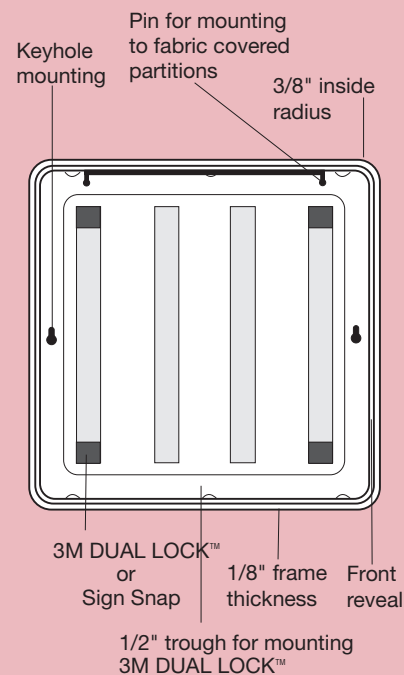
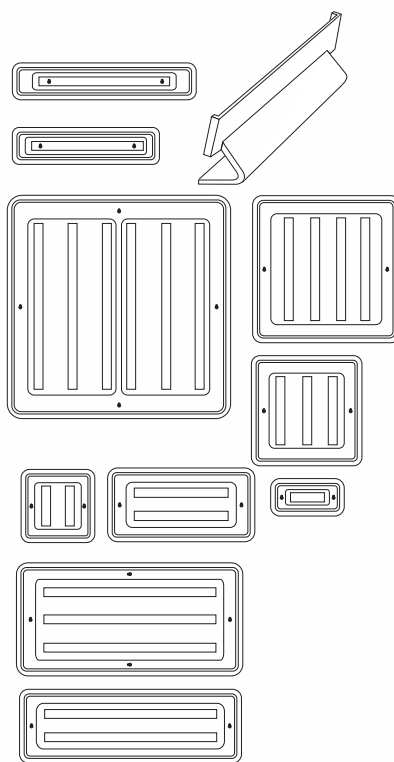

Desk base snaps into 2" x 8" or 2" x 10" frames

DOUBLE SIDED CORRIDOR FRAME WITH CORRIDOR BRACKET

Part No.	Inside Dimension
9222	11 7/8" x 11 7/8"
9288	7 7/8" x 7 7/8"
9266	5 7/8" x 5 7/8"
9220	1 7/8" x 9 7/8"
9242	3 7/8" x 11 7/8"
9262	5 7/8" x 11 7/8"

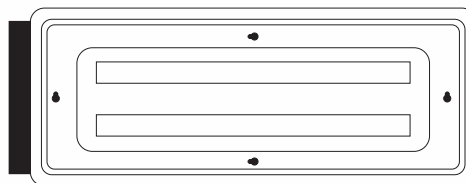

**Custom colors available.
Call for details.**

All holders and frames can be combined for quantity discounts.

See price list for current pricing and quantity discounts.

See Accessories on page 48 for Wire Clips, Dividers and Suction Cups.

DESIGNER 2 FRAMES *In Molded Plastic*



Sign Snap extrusion fasteners snap plates in and out with the use of a suction cup.

Frame dividers section off frames for multiple plates.



12" expandable frame has minimum size of 3 7/8" x 11 7/8" 2" center sections can be added to expand to desired height by a 11 7/8" width.



Designer 2 has keyhole mounting, or pin hangers for mounting to fabric covered partitions.

DIRECTORY Second Floor	
Dermatology Clinic	Suite 201
Diamond Bar Chiropractic	Suite 202
Kirsten Candaele, M.D.	Suite 203
James Johnson, M.D.	Suite 204
Hing Huang, M.D.	Suite 205
Juanita Zavala, M.D.	Suite 206

Designer 2 is a handsome sign system with 1/4" walls, clean square corners, and many features to solve the most difficult sign requirement. Designer2 is molded in 10 sizes and 6 matte plastic colors: **PEWTER GRAY, MEDIUM GRAY, BLACK, WHITE, ALMOND AND BROWN.**

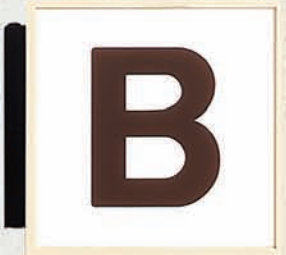

DESIGNER 2 FRAMES

Our DESIGNER 2 FRAME SYSTEM is designed for quality interior signage. Several unique features offered by this system will make designing and mounting interior signage simple.

- Nine sizes in six colors: Pewter Gray, White, Medium Gray, Almond, Brown, and Black.
- One 12" expandable frame that can be extended by adding 2" sections. Plate size starts at 3 7/8" x 11 7/8" to any size in multiples of 2" sections.
- Completely supports 1/16" material so that multiple plates can be used as mini-directories or divided sign messages.
- Plates can be mounted with adhesive-backed 3M DUAL LOCK™ or Sign Snap so that they are tamper resistant but still removable with a suction cup.
- Plates can be permanently mounted to inside of frames with adhesives or two sided transfer tape.
- 1/4" wide divider stripes are available in matching frame colors. These dividers can be used for directories or any sign that may require multiple plates.
- Keyhole mounting for permanent or removable frames.
- Pin system that mounts into a frame for hanging frames from fabric office partitions.
- Base that snaps into a 3120 and 3128 frame for a handsome desk sign.
- Double sided frames with corridor bracket
Corridor bracket mounts in two places with concealed screws.

Part No.	Inside Dimension
3120	1 7/8" x 9 7/8"
3140	3 7/8" x 9 7/8"
3128	1 7/8" x 7 7/8"
9000	6" Desk Base for 3128 and 3120 frames
3188	7 7/8" x 7 7/8"
3166	5 7/8" x 5 7/8"
3144	3 7/8" x 3 7/8"
3112	1 7/8" x 11 7/8" end section
3113	1 7/8" x 11 7/8" mid section
3168	5 7/8" x 7 7/8"
3148	3 7/8" x 7 7/8"
3124	1 7/8" x 3 7/8"

PART NUMBERS 3112 AND 3113 ARE AVAILABLE IN BLACK ONLY.

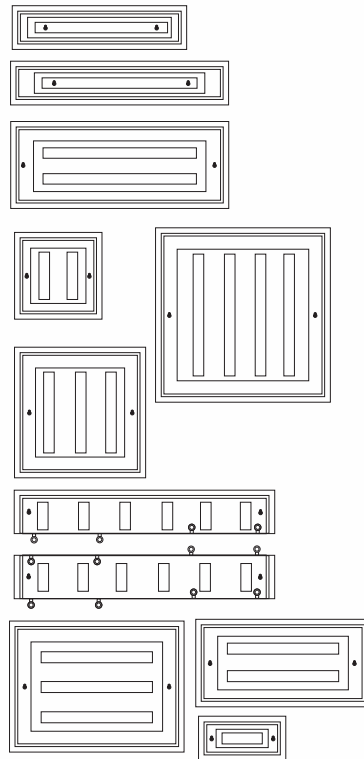

DOUBLE SIDED CORRIDOR FRAME WITH CORRIDOR BRACKET

With 3112 & 3113 frames sections

Part No.	Inside Dimension
3288	7 7/8" x 7 7/8"
3266	5 7/8" x 5 7/8"
3220	1 7/8" x 9 7/8"

Part No.	Inside Dimension
3242	3 7/8" x 11 7/8"
3262	5 7/8" x 11 7/8"
3222	11 7/8" x 11 7/8"

AVAILABLE IN BLACK ONLY.

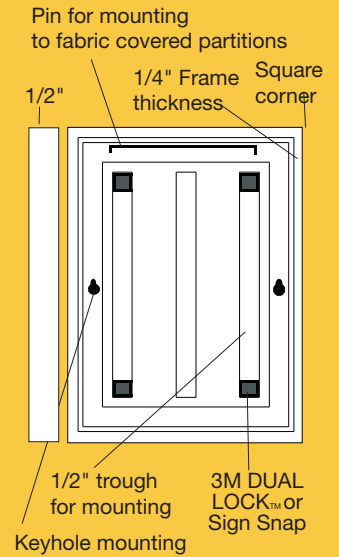

Expandable frame sections fit together by rotating plastic tabs into plastic barrels. These sections can be quickly glued together screwed with #2 flat head self tapping screws, or simply mounted to the wall with each section in succession.

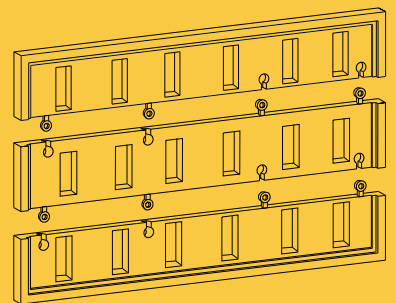

Two end pieces make 4" x 12" (3 7/8" x 11 7/8" plate size). A 2" center section allows the frame to be increased by 2" increments with each additional section.

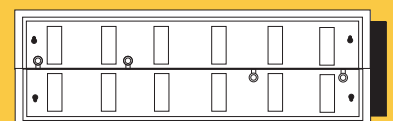

CUSTOM BRACKETS AND PARTITION MOUNTS

Custom acrylic sign holders and partition brackets are available in both 1/16" and 1/8" material. Choose from any of our standard brackets, or we can custom fabricate to your specifications. Please supply a drawing with size specifications, material thickness and quantity. There is a minimum quantity of 25 on custom fabrication. Fax drawing for quote.

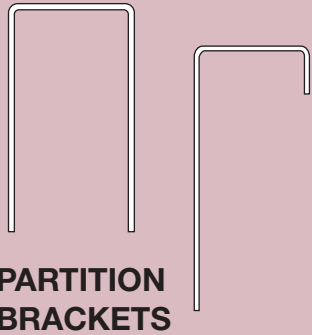

**PARTITION
BRACKETS**

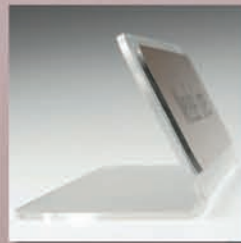
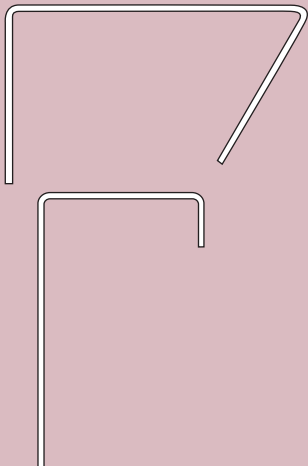

**P111 - 9" Acrylic Sign Holder
PLATE NOT INCLUDED.**

ACCESSORIES

BO9010

Suction Cup Hanger

Has metal hanger for hanging signs on windows and glass doors. 1 3/4" diameter.



BO9800

Fangs Mounting Pins

The definitive answer to mounting of signage on most of today's woven fabric coverings of partitioned office systems, cubicles and soft walls. 1" x 1", Fangs are fully zinc plated. Attach to frame with a droplet of Bond Adhesive 454, also supplied by JRS (BO9801)



Sign panels and lenses can be easily inserted and removed using convenient suction cups.

Tool for removing signs from frames. Two available sizes.



P110

Clear Plastic Hanger

Mounts signs over the top of office partitions. 3 1/2" long, 2 1/8" inside dimension, 1 7/8" high.



BO9000

1 1/2" Suction Cup

BO9001

1" Suction Cup



ACCESSORIES

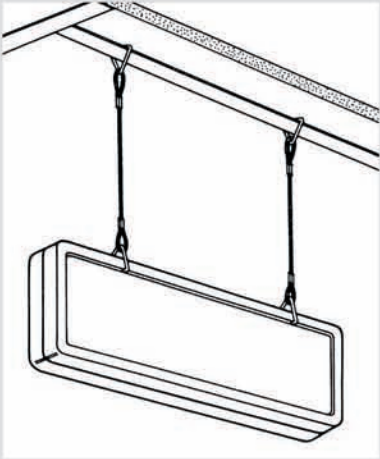

Double sided frames are easily suspended from T-bar ceilings by combining "V" Clips and looped-end cables.



Looped-end Cables

Featuring 1/16" diameter zinc-plated wire rope 12" long with 1" looped ends. Hold up to 30 lbs.

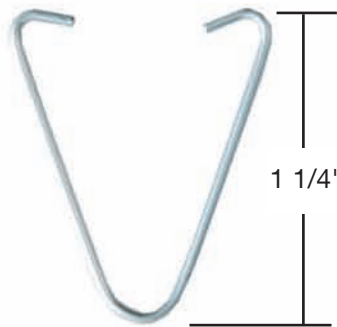

"V" Clip

For mounting to T-bar in suspended ceiling and over double-sided Architectural Frames. Holds up to 25 lbs.

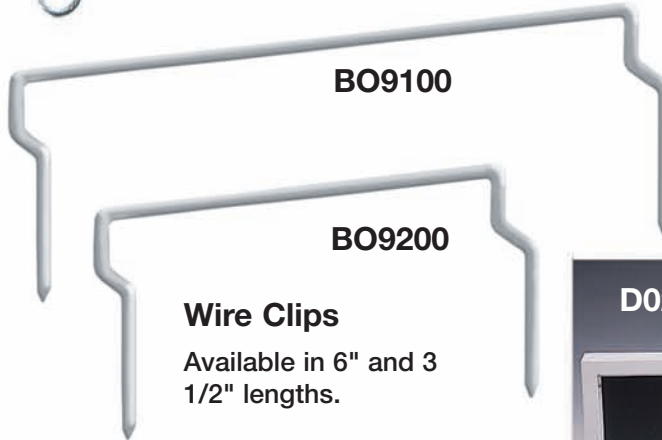

Wire Clips

Available in 6" and 3 1/2" lengths.

Frame Dividers

Section off frames for multiple plates. Custom sizes available, call for pricing.

Dividers are available in 2", 4", 6", 8", 10", 12". Custom sizes available.

BO9450



12" Long

BO9400 and BO9450 can be combined for quantity breaks.



BO9400

Adhesive backed BO9400 engages with BO9450 giving an audible snap to insure positive locking.

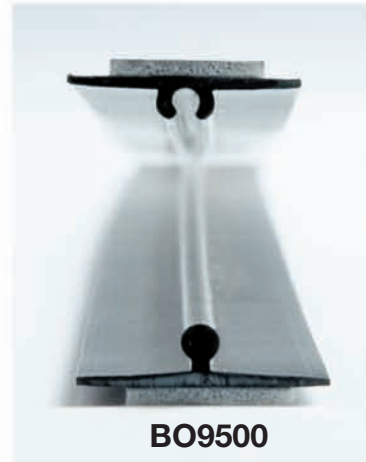

BO9500

Sign Snap

Includes both top, bottom, and adhesive. 1/2" x 12" complete.



Insert wire clip through holes located at top of the frame. Work around bend in wire while gently applying pressure upwards. Snap wire in place between frame and small peg. Apply adhesive inside frame over wire to secure permanent wire placement.

D02, D04, D06, D08, D10, D12

